

2022 INTERSTATE 19



SCAN ME

INTERSTATE 19™

Owner's
MANUAL



AIRSTREAM®



WARNING

Operating, servicing and maintaining a passenger vehicle or off-road vehicle can expose you to chemicals including engine exhaust, carbon monoxide, phthalates, and lead, which are known to the State of California to cause cancer and birth defects or other reproductive harm. To minimize exposure, avoid breathing exhaust, do not idle the engine except as necessary, service your vehicle in a well-ventilated area and wear gloves or wash your hands frequently when servicing your vehicle. For more information go to www.P65Warnings.ca.gov/passenger-vehicle

Disclaimer And Copyright

All information, illustrations and specifications contained in this manual are based on the latest product information available at the time of publication approval. If and when new materials and production techniques are developed that can improve the quality of its product, or material substitutions are necessary due to availability, Airstream reserves the right to make such changes.

Airstream Interstate 19 Owner's Manual

©2021 Airstream, Inc. All rights reserved

Publication Date: October 2021

REV# 02



TABLE OF CONTENTS

INTRODUCTION	1-1	SPRINTER VAN	7-1
SAFETY	2-1	Important Sprinter Information	7-2
Safety Precautions	2-2	Component Identification	7-2
Chemical Sensitivity and Ventilation	2-2	Tires	7-3
Alarms and Detectors	2-3	Changing A Tire	7-5
Fire Extinguisher	2-9	Installing and Removing A Wheel	7-7
Emergency Exit.	2-9	Tire Rotation	7-8
GENERAL INFORMATION	3-1	DRIVING	8-1
Limited Warranty Policy	3-2	Loading	8-2
Service	3-6	Safety	8-4
Camping	3-7	Trailer Towing and Driving Tips	8-4
FLOOR PLANS AND SPECIFICATIONS	4-1	Towing a Trailer.	8-6
Floor Plans	4-2	Towing Your Touring Coach	8-9
Specifications	4-3	Safety Check List	8-9
INTERIOR	5-1	MAINTENANCE	9-1
General Information and Cleaning	5-3	Maintenance Schedule	9-2
Electrical	5-7	Suggested Maintenance and Replacement Parts	9-3
Entertainment Systems.	5-16	Tire Care	9-5
Appliances	5-17	Lithium Iron Phosphate Batteries (House Batteries)	9-6
EXTERIOR	6-1	LPG System	9-8
Exterior Care.	6-2	Plumbing	9-9
Waxes and Polishes	6-2	Drain and Waste System	9-11
How to Care for Your Touring Coach Finish	6-2	Winterizing and Storage	9-13
Roadside Exterior Features	6-4	Electrical Diagrams	9-17
Curbside Exterior Features	6-5	Solar Panel Wiring	9-27
Awning	6-8	Multiplex Controls	9-28
Screen Doors	6-9	Fresh Water Layout	9-31
Hitch Cover	6-10	FAQs and Answers	9-32

Section 1

INTRODUCTION

The Owner's Manual for your new Airstream Touring Coach is designed to respond to the most frequent inquiries regarding the operation, function, and care of the many systems that make modern motorhoming a joy.

The Airstream Touring Coach is integrated into a Sprinter Van, designed and manufactured by Mercedes-Benz. Operation of the Sprinter, its engine, power train, and other related components are discussed in the Mercedes-Benz Sprinter Operator's Manual and other literature provided by Mercedes-Benz. Those systems discussed in the Sprinter literature are warranted by Mercedes-Benz or their suppliers.

Airstream realizes our customers possess varying degrees of expertise in the area of maintaining and repairing the appliances in their touring coach. For this reason, the service and trouble-shooting information found in this manual is directed toward those with average mechanical skills. We also realize you may be more familiar in one area than you are in another. Only you know your capabilities and limitations.

We want you to use this manual, and hope you will find the information contained in it helpful; however, should you ever feel you may be "getting in over your head," please see your dealer to have the repairs made.

The operation and care of component parts such as, refrigerator, furnace, water heater and others are briefly explained in this manual.

All information, illustrations, and specifications contained in this manual are based on the latest product information available at the time of publication approval. Airstream reserves the right to make changes if and when new materials and/or production techniques are developed that can improve the quality of its product, or when material substitutions are necessary due to availability.

We have provided many important safety messages in this manual. Always read and obey all safety messages.



WARNING

A warning is used for a hazardous situation which, if not avoided, could result in death or serious injury to persons.



CAUTION

A caution is used to advise caution when performing actions that could result in minor or moderate injury to persons and/or damage to equipment.

NOTE

A note is used to address practices not related to personal injury. This applies to hazardous situations involving property damage only.

Optional items may be available on all, or particular models. Additionally, some optional items can only be included during the manufacturing phase and cannot later be added to the touring coach. The inclusion of optional items information in this manual does not imply or suggest the availability, application, suitability, or inclusion for any specific unit.

NOTE

Your Mercedes-Benz Sprinter Van Operator's and Warranty Manuals contain important cautions, warnings, operational, and warranty information on the Sprinter and its components. All information in the Sprinter manual should be reviewed and followed for your safety. The Airstream Owner's Manual may provide additional information and tips on the use of the van as a touring coach; however, no information in the Airstream manual should be interpreted as advice or directions to disregard or void the warnings, cautions, or other information contained in the Sprinter's manuals.

Section 2 SAFETY

SAFETY PRECAUTIONS	2-2	What Is Carbon Monoxide	2-5
Weight Distribution	2-2	Conditions that can result in potentially dangerous CO situations	2-5
Tire Safety	2-2	Symptoms of Carbon Monoxide Poisoning	2-5
Appliances and Equipment	2-2	Regular Maintenance	2-6
Generator Safety	2-2	Liquid Propane Gas (LPG)/Carbon Monoxide (CO) Detector	2-6
Mold	2-2	Low Voltage	2-6
CHEMICAL SENSITIVITY AND VENTILATION	2-2	Detector Test	2-7
Chemical Sensitivity	2-2	Basic LPG Safety Information	2-7
Formaldehyde	2-3	If you smell gas	2-8
Ventilation	2-3	Basic Generator Safety Information	2-8
Do Not Smoke	2-3	FIRE EXTINGUISHER	2-9
Medical Advice	2-3	EMERGENCY EXIT	2-9
ALARMS AND DETECTORS	2-3	Safety	2-9
Smoke Alarm.	2-4		
Carbon Monoxide Detector	2-4		
This Carbon Monoxide Detector Is Not	2-4		
Important Safety Precautions	2-4		

Safety Precautions

Many things can be construed as safety related, but the most important is your common sense. If you are careless with matches, cigarettes, flammable material, or any other hazardous material, you surely realize your potential for accidents is greatly increased.

You will find many safety recommendations in this section and throughout the manual. The following recommendations are the ones we consider to be the most important.

Weight Distribution

Touring coach's have fresh water and waste water tanks, a water heater, and storage areas. It gives you great flexibility in loading. With flexibility comes responsibility. If you want to load down all the storage compartments, the amount of fluids may have to be reduced. It is a trade off so plan wisely. Distribute your additional cargo as evenly as possible with the heaviest objects located as low as possible.

Do you really want to carry a full fresh water tank to a RV park 1,000 miles away and then hook up to a city water supply? Even if you're going to a remote area, you can usually fill your water tank shortly before entering the area. Just reducing your load by 10 gallons of water lets you carry an additional 83.5 pounds of cargo.

Tire Safety

Properly maintained tires improve the steering, stopping, traction, and load-carrying capability of your vehicle. Refer to Section 9 - Maintenance for tire care and safety information. Also, be sure to read the Tire Safety Manual Addendum included with your owner's packet.

Appliances and Equipment

The appliances (stove) and equipment (hot water heater/furnace, generator, etc.) typically operate on liquefied petroleum (LP) gas. LP gas is flammable and is contained under high pressure. Improper use may result in a fire and/or explosion. Make sure to follow all instructions and warnings in this manual as well as those in the specific owner's manuals of the appliances and equipment.

Generator Safety

Do not operate the generator in an enclosed building or in a partly enclosed area, such as a garage. Be sure to follow all instructions and warnings in this manual and the generator manufacturer's manual. Refer to Section 5 - Interior for generator information.

Mold

Mold and mold spores exist throughout indoor and outdoor environments. There is no practical way to eliminate all mold and mold spores in the indoor environment; however, the way to control indoor mold growth is to control moisture. Refer to Section 3 - General Information for information on controlling condensation and molds.

Chemical Sensitivity and Ventilation

Chemical Sensitivity

Immediately after the purchase of your new recreational vehicle and sometimes after it has been closed up for an extended period of time, you may notice a strong odor and/or experience a chemical sensitivity. This is not a defect in your recreational vehicle. Like your home, there are many different products used in the construction of recreational vehicles, such as carpet, linoleum, plywood, insulation, upholstery, etc. Formaldehyde is also the by-product of combustion and numerous household products, such as some paints, coatings, and cosmetics. However, recreational vehicles are much smaller than your home and therefore, the exchange of air inside a recreational vehicle is significantly less than in a home. These products, when new or when exposed to elevated temperatures and/or humidity, may off-gas different chemicals, including formaldehyde. This off-gassing, in combination with the minimal air exchange, may cause you to experience irritation of the eyes, nose, and throat, as well as sometimes headache, nausea, and a variety of asthma-like symptoms. Elderly persons and young children, as well as anyone with a history of asthma, allergies, or lung problems, may be more susceptible to the effects of off-gassing.

Formaldehyde

Formaldehyde is a naturally occurring substance and is an important chemical used widely by industries to manufacture building materials and numerous household products. It is also a by-product of combustion and certain other natural processes. Thus, it may be present inside the touring coach. Ventilation of the unit normally reduces the exposure to a comfortable level.

Trace levels of formaldehyde are released from smoking, cooking, use of soaps and detergents, such as carpet shampoos and cosmetics, and many other household products. Some people are very sensitive to formaldehyde while others may not have any reaction to the same levels of formaldehyde. Amounts released decrease over time.

Your Airstream touring coach was manufactured using low formaldehyde-emitting (LFE) wood products, the use of which is typical in the recreation vehicle industry. Formaldehyde has an important role in the adhesives used to bind wood products used in recreation vehicles. The wood products in your coach are designed to emit formaldehyde at or lower than industry guidelines and should not produce symptoms in most individuals.

While LFE wood products typically do not emit formaldehyde at a level that would cause symptoms in most individuals, it is possible, though not likely, for symptoms to occur when the touring coach is not properly ventilated. Ventilation is an essential requirement for touring coach use for many reasons. Any effects of formaldehyde can be greatly reduced by actions such as opening windows, opening roof vents, running the air conditioner, or some combination thereof. In addition, the emission of formaldehyde by these products naturally decreases rapidly over time.

Airstream strongly suggests you take measures to properly ventilate your touring coach on a regular basis. If you have any questions with respect to proper ventilation of your touring coach, please do not hesitate to contact your dealer or Airstream.

Ventilation

To reduce or lessen exposure to chemicals from off-gassing, it is of the utmost importance that you ventilate your recreational vehicle. Ventilation should occur frequently after purchase and at times when the temperatures and humidity are elevated. Remember, off-gassing is accelerated by heat and humidity. Open windows, exhaust vents, and doors. Operate ceiling and/or other fans, roof AC, and use a fan to force stale air out and bring fresh air in. Decreasing the flow of air by sealing the recreational vehicle increases the formaldehyde level in the vehicle's indoor air.

Do Not Smoke

It is recommended you do not smoke inside your recreational vehicle. In addition to causing damage to your recreational vehicle, tobacco smoke releases formaldehyde and other toxic chemicals.

Medical Advice

Questions regarding the effects of formaldehyde on your health should be submitted to your doctor or local health department.

Alarms and Detectors

Parts of this section on the combination Smoke/Carbon Monoxide Detector is a reprint of the manual included with the device and provided to you in the Airstream owner's briefcase. Please read, understand, and follow all aspects of the complete manual before activating and operating the Smoke/Carbon Monoxide Detector. If you have not received the manual, contact your dealership to obtain one, or contact Airstream Customer Relations at 937-596-6111.

NOTE

Dangers, Warnings, and Cautions alert you to important operating instructions or to potentially hazardous situations. Pay special attention to these items.

Smoke Alarm

If smoke is detected you will be alerted by 3 beeps, pause, 3 beeps, pause and the detectors LED will flash red as the alarm is sounding. If the alarm does sound exit immediately and call the Fire Department.

The Smoke/Carbon Monoxide Detector will “chirp” once a minute for at least 30 days when the battery is weak. The battery must immediately be replaced with a fresh one.

Carbon Monoxide Detector

If you hear the Carbon Monoxide alarm move everyone to a source of fresh air. When Carbon Monoxide is detected you will be alerted by 4 beeps, pause, 4 beeps, pause and the detectors LED will flash red as the alarm is sounding. If the alarm does sound exit immediately and call the Fire Department. The manual pertaining to the smoke/Carbon Monoxide detector is included in the paperwork given to you at the dealership. Please read and follow all care, maintenance, and safety information contained in the manual.

Carefully read and understand the contents of the provided instruction manual before using the detector. Store the manual in a safe place for future reference. Pay particular attention to the safety warnings. Pass the manual on to any subsequent users of the alarm.



WARNING

Smoke/Carbon Monoxide detectors have a limited life. The unit should be replaced immediately if it is not operating properly. You should always replace an alarm after 5 years from the date of purchase. Write the purchase date on the space provided on the back of unit.



WARNING

This product is intended for use in ordinary, indoor locations of family living units. It is not designed to measure compliance with occupational safety and health administration (OSHA) commercial or industrial standards. Individuals who are at special risk from Carbon Monoxide exposure by reason of age, pregnancy, or medical condition may consider using warning devices which provide audible and visual signals for Carbon Monoxide concentration under 30 ppm. If in doubt, consult your medical practitioner.

This Carbon Monoxide Detector Is Not

- Designed to detect any gas other than Carbon Monoxide.
- To be seen as a substitute for the proper servicing of fuel-burning appliances.
- To be used on an intermittent basis, or as a portable alarm for spillage of combustion products from fuel-burning appliances.

NOTE

This Carbon Monoxide detector is designed for indoor use only. Do not expose to rain or moisture. Do not knock or drop the alarm. Do not open or tamper with the alarm as this could cause malfunction. The detector will not protect against the risk of Carbon Monoxide poisoning when the batteries are dead or missing. The alarm will only indicate the presence of Carbon Monoxide gas at the sensor. Carbon Monoxide gas may be present in other areas.

Important Safety Precautions

- Ideally, it is recommended that a Carbon Monoxide detector should be installed in or near every room that has a fuel burning appliance such as any room heaters, water heaters, cookers, grills, etc.
- Ensure that the alarm horn can be heard by all those who are intended to hear it. Seek medical help if it is suspected that a user of the RV is suffering from Carbon Monoxide poisoning.
- If the alarm sounds, make sure to investigate the problem. Ignoring the alarm may result in sickness, injury or death. (CO may be present even if nothing is seen or smelled by the user.)
- Room spaces should be well ventilated when household cleaning supplies are used as these may cause a false alarm.
- Alarm should be tested once per week. If further details are required, which do not appear in this manual, contact BRK Brands Inc. First Alert.



WARNING

Activation of your Carbon Monoxide alarm's audible horn indicates the presence of Carbon Monoxide that can kill you. Leave the area immediately!

What Is Carbon Monoxide

Carbon Monoxide (CO) is a highly poisonous gas that is released when fuels are burned. It is invisible, has no smell, and is therefore very difficult to detect with the human senses. Under normal conditions, in a room where fuel-burning appliances are well maintained and correctly ventilated, the amount of CO released into the room by appliances is not dangerous.

These fuels include wood, coal, charcoal, oil, natural gas, gasoline, kerosene, and propane. Common appliances are often sources of CO. If they are not properly maintained, are improperly ventilated, or malfunction, CO levels can rise quickly. CO is a real danger in air-tight vehicles with added insulation, sealed windows, and other weatherproofing that can trap CO inside.

Conditions that can result in potentially dangerous CO situations

1. Excessive spillage or reverse-venting of fuel-burning appliances caused by outdoor conditions, such as:
 - Wind direction and/or velocity, including high gusts of wind.
 - Heavy air in the vent pipes (cold/humid air with extended periods between cycles).
 - Negative pressure differential resulting from use of exhaust fans.
 - Simultaneous operation of several fuel-burning appliances competing for limited internal air.
 - Vent-pipe connections vibrating loose from clothes dryers, furnaces, or water heaters.
 - Obstructions in or unconventional vent-pipe designs which can amplify the above situations.
2. Extended use of un-vented fuel burning devices.
3. Temperature increase that can trap exhaust gases near the ground.

Symptoms of Carbon Monoxide Poisoning

- Mild Exposure - Slight headache, nausea, vomiting, fatigue (flu-like symptoms).
- Medium Exposure - Throbbing headache, drowsiness, confusion, fast heart rate.
- Extreme Exposure - Convulsions, unconsciousness, heart and lung failure. Exposure to CO can cause brain damage and/or death.



WARNING

The Smoke/CO detector is shipped with batteries deactivated. Ask your dealer to activate batteries or activate batteries immediately upon delivery. Failure to follow this warning will remove your protection.



WARNING

Many causes of reported CARBON MONOXIDE POISONING indicate that while victims are aware that they are not well, they become so disoriented that they are unable to save themselves by either exiting the area or calling for assistance. Also young children and pets may be the first to be affected.



WARNING

Test Units in your touring coach after the vehicle has been in storage, before each trip, and at least once a week while in use. If the alarm ever fails to test correctly, have it replaced immediately. If the alarm is not working properly, it cannot alert you to a problem. Failure to test units used in RVs as described may remove your protection.

Regular Maintenance

The Smoke/CO detector has been designed to be as maintenance-free as possible, but there are a few simple things you must do to keep it working properly. Use only listed replacement batteries. The unit may not operate properly with other batteries. Never use rechargeable batteries since they may not provide a constant charge.

- Test it at least once a week.
- Clean the Smoke/CO Alarm at least once a month: gently vacuum the outside of the alarm using your household vacuum's soft brush attachment. A can of clean, compressed air (sold at computer or office supply stores) may also be used. Follow manufacturer instructions for use. Never use water, cleaners, or solvents, since they may damage the unit.
- If the alarm becomes contaminated by excessive dirt, dust, and/or grime, and cannot be cleaned to avoid unwanted alarms, replace the unit immediately.



WARNING

The battery door will resist closing unless batteries are installed. This warns you that the unit will not operate without batteries.



WARNING

Carbon Monoxide is poisonous and can cause confusion, unconsciousness, and death. Follow all instructions, cautions, and warnings in this section and the generator operator's manual.



WARNING

NEVER ignore any alarm. Failure to respond can result in injury or death. The Silence Features are for your convenience only and will not correct a problem. Always check your touring coach for a potential problem after any alarm. Failure to do so can result in injury or death.

Liquid Propane Gas (LPG)/Carbon Monoxide (CO) Detector



This detector has a five-year life; see end-of-life notification in the detectors manual. Please read the entire detector manual before operating the unit.

The LPG/CO detector is located in the galley area. LPG is a mixture of gases produced and sold commercially as a fuel for heating and cooking appliances. LPG is highly flammable and, as a result, can be explosive if ignited under certain circumstances. LPG is heavier than air and, if confined in a closed space, will accumulate close to the floor. The LPG/CO detector is designed to alarm when propane gas exceeds 10% of the lower-explosive-limit for more than 30 seconds or if CO gas reaches unsafe levels. When propane gas is detected the horn will sound with constant beeps and the red LED will be on. If CO gas is detected the horn will sound with 4 rapid chirps followed by a 4 second pause and the red LED will flash rapidly.

Your LPG/CO detector is wired directly to your touring coach battery and incorporates a 1-amp, in-line fuse. It has no internal battery backup. In normal stand-by mode, the LED indicator will be green.

Low Voltage

The operating voltage for the detector is 12 VDC. The actual voltage supplied to the detector in a recreational vehicle may drop below the minimum 8 VDC. The detector provides the user with a low voltage warning before reaching that level and will provide additional distinct, clear warnings and alarms after the 8 VDC level is reached. However, if available power supplied to the unit is below the operating voltage of 8 VDC, the detector will not detect gas or provide protection against dangerous levels of LPG.

NOTE

If the low voltage warning sounds, the detector will need to be reset by disconnecting the battery, before normal operation will occur.

Detector Test

If the Silence/Test button is pressed while in normal operation, the alarm will perform a self test of the CO sensor, propane sensor and battery voltage. It is recommended to perform a self test weekly, after power up from storage, and before each trip. If the self test passes, the alarm will perform 2 cycles of the CO horn pattern (4 rapid chirps followed by a 4 second pause), followed by 2 cycles of the propane horn pattern (constantly beeping).

**WARNING**

Activation of this detector indicates the possible presence of LPG, which can cause an explosion and/or fire, causing serious injury or death. This normally indicates a leak in the LPG installation or an LPG appliance. Extinguish all open flames, open your windows and door, and evacuate the unit immediately. Do not activate any electrical switch. Turn off the LPG using the remote shut off switch.

Do not re-enter your unit until a qualified repair technician has corrected the problem and certified the system as safe.

**WARNING**

It is not recommended that the detector be disconnected from the battery during periods of storage. There is a small heater on the sensor of the device that burns away impurities in the air during periods of normal use. During periods when power is interrupted, impurities can build up on the sensor. When power is returned to the detector, the detector alarm may activate until the impurities are burned off. This could take a number of hours, during which time the alarm will be constantly on.

**WARNING**

Have a qualified technician check your LPG system annually or if you detect any signs of leaks or malfunctions.

NOTE

Refer to Section 5 - Interior and Section 6 - Exterior for additional LPG warnings and safety information.

Basic LPG Safety Information

A warning label has been positioned in the cooking area to remind you to provide an adequate supply of fresh air for combustion. Unlike homes, the amount of oxygen supply is limited due to the size of the recreational vehicle, and proper ventilation when using the cooking appliances will avoid dangers of asphyxiation. It is especially important that cooking appliances not be used for comfort heating as the danger of asphyxiation is greater when the appliance is used for long periods of time.

Portable fuel burning equipment, including wood and charcoal grills and stoves, shall not be used inside the recreational vehicle. The use of this equipment inside the recreational vehicle may cause fires or asphyxiation.

A Warning Label has been located near the LP gas container. This label reads: DO NOT FILL CONTAINER(S) TO MORE THAN 80% PERCENT OF CAPACITY. Overfilling the LP gas container can result in uncontrolled gas flow that can cause a fire or explosion. A properly filled container will contain approximately 80 percent of its volume as liquid LP gas.

**WARNING**

DO NOT store LP containers within vehicle. LP containers are equipped with safety devices that vent gas should the pressure become excessive.

**WARNING**

DO NOT use cooking appliances for comfort heating. Cooking appliances need fresh air for safe operation. Before operation, open overhead vent or turn on exhaust fan and open window.

If you smell gas

- Extinguish any open flames, pilot lights and all smoking materials.
- Do not touch electrical switches.
- Shut off the gas supply using the remote shut off switch.
- Open doors and other ventilating openings.
- Leave the area until odor clears.
- Have the gas system checked and leakage source corrected before using again.

LP gas regulators must always be installed with the diaphragm vent facing downward. Regulators that are not in compartments have been equipped with a protective cover. Make sure that regulator vent faces downward and that cover is kept in place to minimize vent blockage that could result in excessive gas pressure causing a fire or explosion.

The regulator at the LP tank is under a gray, plastic cover. The protective cover helps to keep the vent on the regulator from being clogged by wasps or ice, but the regulator should be checked regularly to make sure the vent remains clear.



WARNING

Do not attempt to seal regulator cover.



WARNING

Check vent each time tank is filled to make sure it is clear of obstructions.



WARNING

Have a qualified technician check your LP Gas system annually or if you have any signs of leaks or malfunctions.

Basic Generator Safety Information

1. Never sleep in the vehicle with the generator running without ensuring the Carbon Monoxide detector is working. Primary protection against inhaling Carbon Monoxide is daily (every eight hour) inspection for visible and audible generator exhaust system leaks.
2. DO NOT operate the generator in an enclosed building or in a partly enclosed area such as a garage.
3. Review the safety precautions for fuel and exhaust fumes in the generator manual.
4. DO NOT operate the generator when the recreation vehicle is parked in high grass or brush. Heat from the exhaust could cause a fire in dry conditions.
5. DO NOT simultaneously operate generator and a ventilator which could result in the entry of exhaust gas. When exhaust ventilators are used, we recommend that a window on the opposite side of the unit “upwind” of exhaust gases be opened to provide cross ventilation.
6. When parked, orient the vehicle so that the wind will carry the exhaust away from the vehicle. DO NOT open nearby windows, ventilators, or doors into the passenger compartment, particularly those which can be “down wind”, even part of the time.
7. DO NOT operate the generator when parked in close proximity to vegetation, snow, buildings, vehicles, or any other object that could deflect the exhaust under or into the vehicle.
8. DO NOT touch the generator when running, or immediately after shutting off. Heat from the generator can cause burns. Allow the generator to cool before attempting maintenance or service.



WARNING

Your Touring Coach is equipped with an Automatic Generator Start System. Exposure to carbon monoxide, moving parts, and electricity hazards are possible due to unexpected automatic starting.

NOTE

The generator is located under the touring coach between the rear axles.

Fire Extinguisher



The fire extinguisher should be checked for charge on a regular basis. Make sure your family knows how to release the extinguisher storage bracket and how to properly operate the extinguisher. Check with your local fire department for professional advice on its operation and use if you find the directions on the extinguisher unclear. They will be able and willing to assist you and your family.



WARNING

Read the directions carefully on the fire extinguisher. If there is any doubt on the operation you and your family should practice, then replace or recharge the extinguisher. You will find your local fire department will be happy to assist you and answer any questions.



WARNING

Do not smoke inside the touring coach. Keep matches out of reach of small children. Do not clean with flammable material. Keep flammable material away from open flame. We have all heard these warnings many times, but they are still among the leading causes of fires.

Emergency Exit

There are three avenues of escape from the touring coach in the event of an emergency, the driver's door, the passenger door, and the rear doors. As always, safety should be one of your top priorities. Make sure you and everyone traveling with you can operate these doors and exit rapidly without light. A little planning and a quick practice session at each camping site is well worth the time it may take.

Safety

As always, safety should be a top priority. Ensure that you, and everyone traveling with you, can quickly operate the main door and rear doors in the dark. Plan for other means of escape in case these designated exits are blocked.



WARNING

At each campsite, make sure you have not parked in such a manner as to block the operation of the doors or the escape avenues by being too close to trees, fences, or other impediments. Scenic views are one reason for traveling, but do not park so the beautiful lake or steep cliff is just outside your doors. Do not block access to the doors from the inside or outside of the vehicle.

Section 3

GENERAL INFORMATION

LIMITED WARRANTY POLICY	3-2	CAMPING	3-7
This Limited Warranty Covers	3-2	Suggested Pre-Travel Check List	3-7
Coverage Ends	3-2	Exterior	3-7
Limitation Of Implied Warranties	3-2	Interior	3-7
Disclaimer Of Incidental And Consequential Damages	3-2	Touring Coach Equipment and Accessories	3-7
Repair Remedy	3-2	Motoring Essentials	3-7
Back-Up Remedy	3-3	Overnight Stop	3-7
What Is Not Covered	3-3	Overnight or Weekend Trips	3-8
Obtaining Warranty Service	3-4	Longer Trips	3-8
Consumer Arbitration Program	3-5	Extended Stay	3-8
Events That Discharge Airstream's Obligations Under This Limited Warranty	3-5	Leveling	3-8
Legal Remedies	3-5	Effects of Prolonged Occupancy	3-9
Airstream Limited Warranty Excludes	3-5	About Molds	3-9
Normal Wear	3-5	What are molds	3-9
Accident	3-5	What factors contribute to mold growth	3-10
Abuse	3-5	How can mold growth be inhibited	3-10
Exposure	3-5	Waste Water System.	3-10
Overload	3-5	Things Not to Put into Toilet or Drains	3-10
Chemical Gassing	3-5	Drain System	3-10
Sprinter Van	3-6	Winter Traveling	3-11
SERVICE	3-6	Heated Tanks	3-11
Reporting Safety Defects	3-6		

Limited Warranty Policy

This Limited Warranty Covers

(i) The first retail owner and any subsequent owners
(ii) ONLY those portions of a NEW motorhome not excluded under the section “What is Not Covered”, when sold by an authorized dealership; and, (iii) ONLY defects in workmanship performed and/or materials used to assemble those portions of your motorhome not excluded under the section “What is Not Covered”. “Defect” means the failure of the workmanship performed and/or materials used to conform with the design and manufacturing specification and tolerances of Airstream. The Limited Warranty is transferable and the subsequent owner’s warranty coverage period shall be the unexpired balance of the original warranty coverage period. A completed copy of the Warranty Transfer Form must be submitted to Airstream at the time of resale.

When you request and accept the performance of warranty repairs under the terms of this Limited Warranty, you are accepting all terms of this Limited Warranty, including by way of example, warranty limitations and disclaimers, the forum selection clause and the clause reducing the time period when suit must be filed for breach.

If any term of condition in this limited warranty conflicts with your state’s Uniform Commercial Code (“UCC”) as interpreted by courts within your state, the provisions of your state’s UCC are varied as allowed for by USS 1-302.

Coverage Ends

36 months after the first retail owner first takes delivery of the motorhome from an authorized dealership or after the odometer reaches 36,000 miles, whichever occurs first. Any action for breach of this warranty or any implied warranties must be commenced not more than 37 months after breach. Some states do not allow the reduction of the time when a breach of warranty claim must be commenced, so the reduction in time when a breach of warranty claim must be commenced may not apply to you.

Limitation Of Implied Warranties

Implied warranties arising under applicable law, if any, including but not limited to implied warranties of merchantability or fitness for a particular purpose, are hereby limited in duration to the term of this limited warranty and are limited in scope of coverage to those portions of the motorhome covered by this limited warranty. There are no express warranties or any implied warranties of merchantability on those portions of the motorhome excluded from coverage. There is no warranty of any nature made by Airstream beyond that contained in this limited warranty. No person has authority to enlarge, amend or modify this limited warranty. The dealer is not Airstream’s agent. Airstream is not responsible for any undertaking, representation or warranty made by any dealer or others beyond those expressly set forth within this limited warranty. Some states do not allow limitations on how long an implied warranty lasts, so the above limitations may not apply to you.

Disclaimer Of Incidental And Consequential Damages

Airstream disclaims any and all incidental and consequential damages, including but not limited to expenses such as transportation to and from dealerships and Airstream repair facilities, loss of time, loss of pay, loss of use, inconvenience, commercial loss (including but not limited to lost profits), towing charges, bus fares, vehicle rental, service call charges, gasoline expenses, incidental charges such as telephone calls and facsimile transmissions, and expenses for lodging and moisture damage such as mold and mildew as well as rust and corrosion. This disclaimer is independent of any failure of the essential purpose of any warranties provided with the motorhome, and shall survive any determination that a warranty failed of its essential purpose. Some states do not allow the exclusion or limitation of incidental or consequential damages, so the above limitation or exclusion may not apply to you.

Repair Remedy

Airstream’s sole and exclusive obligation is to repair any covered defects discovered within the warranty coverage period if: (1) within 10 days of your discovery of a defect you notify Airstream OR an authorized dealership of the defect; AND (2) you deliver your Motorhome to Airstream OR an authorized dealership at your cost and expense.

Back-Up Remedy

If the primary repair remedy fails to successfully cure any defect after a reasonable number of repair attempts, your sole and exclusive remedy shall be to have Airstream pay an independent service shop of your choice to perform repairs to the defect OR if the defect is incurable, have Airstream pay diminution in value damages. The repair remedy and the back-up remedy must both be exhausted and these remedies must fail to fulfill their essential purpose before you can seek other legal or equitable remedies for breach of this express warranty or for breach of any implied warranty. This limited warranty is not a warranty that promises or extends to future performance because the warranty does not make a representation on how your motorhome will perform in the future but instead represents only what the remedy will be if a defect exists.

Unless prohibited by state law, repairs will not extend the time when you must commence a breach of warranty claim and shall not extend the warranty coverage period. Any performance of repairs after the warranty coverage ends OR any performance of repairs to those portions of your motorhome excluded from coverage shall be considered "good will" repairs. Warranty repairs should be expected. Airstream may use new and/or remanufactured parts and/or components of substantially equal quality to complete a repair. Damage to interior or exterior surfaces, trim, upholstery and other appearance items may occur at the factory during assembly, during delivery of the motorhome to your selling dealer or on the selling dealer's lot. Normally, any damage is detected and corrected at the factory or by the selling dealer during the inspection process. If you discover any damage when you take delivery of your motorhome, you MUST notify your dealer OR Airstream within 10 days of the date of purchase to have damage repaired at no cost to you. Minor adjustments, such as adjustments to the interior or exterior doors, drawers, latches will be performed at no cost to you by your selling dealer during the first 90 days of warranty coverage; thereafter, such adjustments are your exclusive responsibility as normal maintenance.

What Is Not Covered

1. Tires, batteries, stereo, television, range/stove, furnace, refrigerator, air conditioner, toilet, water heater, microwave, generator, glass breakage, and other materials, parts and components warranted by persons or entities other than Airstream. Please refer to the warranties of component manufacturers for terms and conditions of coverage;
2. Accessories and equipment that are working as designed, but which you are unhappy because of the design
3. Any part or component of the vehicle that was not manufactured or installed by Airstream;
4. Normal deterioration due to wear or exposure, including but not limited to upholstery, flooring rust, corrosion, oxidation, and cosmetic blemishes;
5. Normal maintenance and service items, including but not limited to light bulbs, fuses, lubricants, sealants and seals, door adjustments, and awning tension;
6. After-market equipment or accessories installed on the vehicle after completion of manufacture by Airstream, or any defects or damage caused by such items;
7. Vehicles not purchased through an authorized dealer of Airstream and vehicles purchased directly or indirectly through auction, salvage, repossession, or other non-customary sale means;
8. Any motorhome used other than for temporary recreation purposes, including, but not limited to, use of the motorhome for residential, rental, business and commercial purpose or any motorhome purchased by, registered by, or titled in the name of a business association (such as any LLC, corporation, or partnership). If the motorhome owner or user files a tax form claiming a business or commercial tax benefit or income related to the motorhome, it shall be irrefutable that the motorhome has been used for rental, commercial or business purposes.

General Information

9. Defects or damage caused by, in whole or in part, or in any way related to: Accidents, misuse (including off-road use), or negligence; Failure to comply with the instructions set forth in any owner's manual provided with the vehicle; Alteration or modification of the vehicle except such alterations or modifications approved in writing by Airstream; Acts of God or other environmental conditions, such as lightning, hail, salt causing rust, or other chemicals in the atmosphere; De-icing agents or other chemicals applied to the vehicle; Failure to properly maintain or service the vehicle, including but not limited to the maintenance of lubricants, sealants, and seals; Condensation and the results of condensation including water damage and the growth of mold or mildew. Mold and mildew are natural growths given certain environmental conditions and are not covered by the terms of this Limited Warranty; The addition of weight to the vehicle that causes the total weight to exceed applicable vehicle weight ratings, or addition of weight causing improper distribution of the weight of the vehicle; Failure to seek and obtain repairs in a timely manner; Failure to use reasonable efforts to mitigate damage caused by defects; Failure to properly ventilate the vehicle; Improper electric power supply or improper vehicle hookup to other facilities; and, Acts or omissions of any person or entity other than Airstream. (Note: It shall be concluded that the travel trailer has been used for commercial and/or business purposes if the travel trailer owner or user files a tax form claiming any business or commercial tax benefit related to the travel trailer, or if the travel trailer is purchased, registered or titled in a business name.)

Obtaining Warranty Service

In order to obtain warranty service under this Limited Warranty, the owner must do all of the following:

1. Owner and dealer representative must complete and return the Customer Performance Checkout within 10 days from delivery of the vehicle,
2. Notify Airstream or one of its authorized, independent dealers of any claimed defect within the warranty period or 10 days thereafter,
3. Provide notification of a defect within 10 days of discovery of that defect, and
4. Promptly return the motorhome to an authorized Airstream dealer or Airstream for repairs.

If you believe a defect covered by this Limited Warranty still exists after an attempted repair by an authorized Airstream dealer, you must contact Airstream at the following address, specifying:

1. The complete serial number of the motorhome,
2. The date of original purchase and the date of original delivery,
3. The name of the selling dealer, and
4. The nature of the problem and the steps or service which have been performed.

Airstream, INC.

428 West Pike Street

P.O. Box 629

Jackson Center, Ohio 45334-0629

Attention: Owner Relations Department

Airstream may direct you to an authorized Airstream dealer, or may request that you bring your motorhome to the Airstream factory in Jackson Center, Ohio for repairs.

Airstream does not control the scheduling of repairs at its authorized Airstream dealers, and repairs at the Airstream factory may not be immediately available. Therefore, you may encounter delays in scheduling repairs and/or completion of repairs. All costs associated with transporting the motorhome for any warranty service shall be the sole responsibility of the owner.

Consumer Arbitration Program

For recreation vehicles purchased in the State of California, Airstream, Inc. participates in the Consumer Arbitration Program for Recreation Vehicles (CAP-RV). This third-party dispute resolution program is available, at no charge to you, to settle unresolved warranty disputes for recreation vehicles. This dispute resolution program reviews eligible product and service related complaints involving warranty covered components. To find out more about this program, or to request an application/brochure, please call the Arbitration Administration office toll-free 800.279.5343. The CAP-RV program operates as a certified mechanism under the review of the California Arbitration Certification Program. Members of the armed forces who purchased the vehicle in California, or who were stationed in or a resident of California at the time of purchase (regardless of state of purchase) or who are stationed in California at the time of application to this program may utilize the CAP-RV program.

Events That Discharge Airstream's Obligations Under This Limited Warranty

Misuse or neglect, accidents, unauthorized alteration, failure to provide reasonable and necessary maintenance (see Owner's Manual), damage caused by off road use, collision, fire, theft, vandalism, explosions, overloading in excess of rated capacities, odometer tampering, and use of the motorhome for commercial, business, or rental purposes shall discharge Airstream from any express or implied warranty obligation to repair any resulting defect.

Legal Remedies

Exclusive jurisdiction for deciding legal disputes relating to alleged breach of express warranty and breach of implied warranties arising by operation of law as well as those relating to representations of any nature rests in the courts within the state of manufacture, which is Ohio. Also, this limited warranty shall be interpreted and construed in accordance with the laws of the state of Ohio. Any and all claims, controversies, and causes of action arising out of or relating to this limited warranty, whether sounding contract, tort or statute, shall be governed by the laws of the state of Ohio, including its statute of limitations, without giving effect to any conflict of law rule that would result in the application of the laws of a different jurisdiction.

Airstream Limited Warranty Excludes

Normal Wear

Items such as curtains, upholstery, floor coverings, and window, door, and vent seals will show wear or may even wear out within the 3-year warranty period, depending upon the amount of usage, weather, and atmospheric conditions.

Accident

We strongly urge our dealers and customers to inspect the touring coach upon receipt of delivery for any damage caused by accident while being delivered to the dealer, or while it is on the dealer's lot. Damage of this nature becomes the dealer or customer's responsibility upon acceptance of delivery, unless Airstream is notified and the person making the delivery verifies the damage. Glass breakage, whether obviously struck or mysterious, is always accidental and covered by most insurance policies.

Abuse

Lack of customer care and/or improper maintenance will result in early failure for which Airstream cannot be held responsible.

Exposure

Deterioration by sunlight is possible to such items as tires, curtains or upholstery. Steel or metal surfaces are subject to the elements, causing rust and corrosion that is normal and beyond the control and responsibility of Airstream.

Overload

Overload Damage due to loading beyond capacity or to cause improper balance is not covered by the Airstream Limited Warranty. The Airstream Touring Coach is engineered to properly handle any normal load. There are limits to the amount of load that can be safely transported depending upon speed and road conditions. If these limits have been exceeded, the Airstream Limited Warranty will not cover resulting damage. For additional information on the load capacity of your touring coach, consult your Sprinter and Airstream Owner's Manuals or gross vehicle weight rating plate.

Chemical Gassing

Chemical gassing is not a "Defect" in your recreational vehicle and is not covered by the Limited Warranty. Please follow the recommendations in this manual to address this concern.

General Information

Sprinter Van

Airstream, Inc., does not accept any responsibility in connection with any of its touring coach's for the Sprinter Van or its components. The Sprinter Van and its components are covered by Mercedes-Benz Warranties as explained by Sprinter literature provided. Your Sprinter Van and its components are pre-checked by its manufacturer before delivery to Airstream. All service to the Sprinter Van and its components must be performed by Mercedes-Benz Sprinter designated service points according to the manufacturer's warranty and service policies. The literature provided with each touring coach gives important information concerning its warranty coverage, maintenance, and operation.

The Airstream Interstate Nineteen Owner's Manual may provide additional information and tips on the use of the van as a touring coach, however, no information, in whole or in part, in any Airstream manual should be interpreted as advice or directions to disregard or void the Warnings, Cautions, Notices, or other information contained in the Sprinter's manuals.



WARNING

Your Mercedes-Benz Sprinter Van Operator's and Warranty Manuals contain important cautions, warnings, operational, and warranty information on the Sprinter and its components. All information in the Sprinter manual should be reviewed and followed for your safety.

Service

Before leaving the factory, every vital part of the touring coach is tested for performance. Each test is signed and certified by an inspector. After the touring coach arrives on your dealer's lot, all vital parts and systems are again tested. When you take delivery of your new touring coach, you will receive a complete check out.

At that time, a specified list of performance checks on your touring coach equipment will be conducted, and any deficiencies you have experienced since taking delivery will be corrected.

Please contact your dealer if your touring coach needs service. Major service under your Airstream Limited Warranty is available through our nationwide network of Airstream Dealer Service Centers. An up-to-date list of Dealer Service Centers will be sent to you with an Owner's Survey shortly after your touring coach is delivered. Our website, www.Airstream.com also has a dealer locator on it. This list is current as of the date of this publication.

Occasionally, dealerships change or new dealers are added who may not appear on this list. For this reason, it is suggested you contact your local dealer from time to time for an updated list. Additional copies are available if you need them. All centers operate on an appointment basis for the utmost efficiency.

When you require service for your touring coach from the Airstream Factory Service Center or a Certified Dealer Service Center, please contact the service manager for an appointment, and inform them if you are unable to keep the appointment date or wish to change it. Service may be arranged at the Factory Service Center by contacting the Service Coordinator at:

Airstream Factory Service Center

428 West Pike Street

P.O. Box 629

Jackson Center, Ohio 45334-0629

Phone: (937) 596-6111 or (877) 596-6111

NOTE

Connected RV features and systems may be turned off while in a service facility for the safety of our technicians. You might have to re-pair your personal device after service appointment.

Reporting Safety Defects

If you believe your vehicle has a defect which could cause a crash or could cause injury or death, you should immediately inform the National Highway Traffic Safety Administration (NHTSA), in addition to notifying Airstream, Inc.

If NHTSA receives similar complaints, it may open an investigation, and if it finds that a safety defect exists in a group of vehicles, it may order a recall and remedy campaign. However, NHTSA cannot become involved in individual problems between you, your dealer, or Airstream Inc.

To contact NHTSA, you may either call the Vehicle Safety Hotline toll-free at 1-888-327-4236 (TTY: 1-800-424-9153), go to <http://www.safercar.gov>, or write to:

Administrator

NHTSA

1200 New Jersey Avenue, S.E.

Washington, DC 20590

You can also obtain other information about motor vehicle safety from <http://www.safercar.gov>.

Camping

Suggested Pre-Travel Check List

Exterior

1. Verify power cord is stored.
2. Verify leveling jacks are up (if equipped).
3. Verify water and sewer hoses are stored.
4. Double check all hitch connections (if towing).
5. Look under, over, and around the vehicle for any overlooked items.
6. Check exterior lighting.
7. Check torque of lug nuts.
8. Check tires for correct pressure.

Interior

1. Turn off water pump, water heater, and furnace.
2. Close windows and vents.
3. Close all interior cabinet doors.
4. Latch refrigerator door. (Seal containers first.)
5. Latch microwave.
6. Secure, stow, and latch for travel anything that will move, fall, fly, or open.
7. Drain toilet bowl.
8. Turn off 12-volt lights.

Touring Coach Equipment and Accessories

1. Water hose, 5/8-in. high-pressure, tasteless, odorless, non-toxic (two 25-ft. sections).
2. Y connection - water hose.
3. Holding tank cleaner and deodorizer.
4. Power cord adapter, 30-amp capacity.
5. 30-ft. electric cord, 30-amp capacity.
6. Wheel chocks.
7. Torque wrench.
8. Quality tire gauge.
9. Emergency light and first aid kits.

Motoring Essentials

1. Touring coach registration.
2. Carry driver's license.
3. In Canada, bring along a non-residence liability insurance card and your passport.
4. In Mexico, you must have special auto insurance.
5. Carry an extra set of the ignition keys in a separate pocket or in your wallet.
6. Keep an operating flashlight with fresh batteries in the glove compartment.
7. Pack the trunk so that you can reach the tools without completely unpacking.
8. Carry your pet's dish, food, leash, and health and registration papers.

Overnight Stop

In time you will develop a knack for spotting wonderful little roadside locations by turning off the main highway and exploring. There are many modern recreational vehicle parks, including State, County, and Federal parks with good facilities, where you may obtain electrical, water, and sewer hookups and connections. Directories are published which describe in detail these parks and tell what is available in the way of services and hookups.

All you need to do to enjoy the self-contained luxury while boondocking is to:

1. Turn on the 12-volt battery disconnect switch to provide power to your components.
2. Turn on the exterior LP gas supply, if you need to cook or start the generator.
 - Generator must be started to run the air conditioner.
 - Inverter will need to be turned on to power the entertainment devices. To conserve battery power, turn off the inverter when not in use.
3. Turn on the water pump and open faucets until air is expelled from the system.

Before moving on, turn off the LP gas and water pump. Check your campsite, both for cleanliness and to be sure you have not left anything behind. Make sure everything is properly stowed.

General Information

Overnight or Weekend Trips

On overnight or weekend trips, chances are you will not use up the capacity of the holding tanks. Deplete the water supply, if using the system moderately or conservatively. You will need to maintain the level of your battery during this time. The batteries will shut down at 10.5 volts. It is recommended you charge the batteries, by plugging into shore power or by starting your generator, when they reach 12 volts.

Longer Trips

On a longer trip, when you have stayed where sewer connections and utility hookups were not available, it will be necessary for you to stop from time to time to dispose of the waste in the holding tank and replenish the water supply. Many truck stops and gas stations, chain and individually owned, have installed sanitary dumping stations for just this purpose. Booklets are available that list these facilities.

When you stop for the night, your Airstream Touring Coach is built to be safely parked in any spot that is relatively level and where the ground is firm. Your facilities are with you. You are self-contained. Try to pick as level a parking spot as possible.

Extended Stay

Making a long trip is not very different from making a weekend excursion. Since everything you need is right at hand, you are at home wherever you go. When packing for an extended trip, take everything you need, but only what you need.

Hook up to water by attaching a ½ -inch minimum high-pressure water hose to the city water service.

Plug the 120-volt, 30-amp electrical cable into the city power service. The SmartPlug incorporates a reverse polarity feature which will include a series of light codes to let you know the condition of the power coming from the campsite power pedestal. Please refer to the provided SmartPlug owner's manual for more information on reverse polarity and the light codes.

To use the generator, you simply start it. All switching is done automatically. The generator can be started from any of the Multiplex Systems control panels. It is easier on your generator, and appliances, if you'll allow the generator to reach its normal operating speed (about a minute) prior to applying heavy current loads.

Your Touring Coach is equipped with an Automatic Generator Start System (AGS). The purpose of an AGS system is to automatically start (and run) the generator when the 12 volt electrical system (house batteries) drops to a pre-determined level. See Section 5 for more information on the AGS System.

A Cable/Satellite TV connection is located in the exterior compartment along with the switches for the dump valves, macerator pump, and macerator pump high-pressure hose reel.

Turn on the exterior LP remote power switch. If you have not used the LP system for some time, light lighting a cooktop burner to bleed any air from the system will make it easier to start other appliances including the furnace.

When you stay for extended periods where electric or water hookups are not available, you must make regular checks on the condition of your 12-volt batteries and the contents of your water tank (Multiplex control panel). Carry drinking water in a clean bucket to refill your tank. When your waste tank nears capacity, move your touring coach to a dumping location.

Leveling

When you plan to stay in the same place for several days, weeks, or months, you will want your touring coach to be as level as possible. Check the attitude with a small spirit level set on the inside work counter. If a correction is necessary, then you must first level from side to side. This can be done most easily by driving up a small ramp consisting of 2 in. x 6 in. boards tapered at both ends. Airstream does not recommend placing tires in a hole for leveling. Refer to Section 7 - Sprinter Van for more information on tires.

Effects of Prolonged Occupancy

Your touring coach was designed primarily for recreational use and short-term occupancy. If you expect to occupy the touring coach for an extended period, be prepared to deal with condensation and the humid conditions that may be encountered. The relatively small volume and tight compact construction of modern recreation vehicles mean that the normal living activities of even a few occupants will lead to rapid moisture saturation of the air contained in the touring coach and the appearance of visible moisture, especially in cold weather.

Just as moisture collects on the outside of a glass of cold water during humid weather, moisture can condense on the inside surfaces of the touring coach during cold weather when relative humidity of the interior air is high. This condition is increased because the insulated walls of a recreation vehicle are much thinner than house walls. Estimates indicate that two adults can vaporize up to one-and-a-half gallons of water daily through breathing, cooking, bathing, and washing. Unless the water vapor is carried outside by ventilation or condensed by a dehumidifier, it will condense on the inside of the windows and walls as moisture, or in cold weather as frost or ice. It may also condense out of sight within the walls or the ceiling where it will manifest itself as warped or stained panels. Appearance of these conditions may indicate a serious condensation problem. When you recognize the signs of excessive moisture and condensation in the touring coach, action should be taken to minimize their effects.

NOTE

Your touring coach is not designed, nor intended, for permanent housing. Use of this product for long term or permanent occupancy may lead to premature deterioration of structure, interior finishes, fabrics, carpeting, and drapes. Damage or deterioration due to long-term occupancy may not be considered normal, and may under the terms of the warranty constitute misuse, abuse, or neglect, and may therefore reduce the warranty protection.

To avoid condensation problems, try to follow these tips to help alleviate excess moisture:

- Allow excess moisture to escape to the outside when bathing, washing dishes, hair drying, laundering, and using appliances and non-vented gas burners. Always use an exhaust fan when cooking.
- Keep the bathroom door closed and the vent or window open when bathing and for a period of time after you have finished.
- If you are experiencing condensation, you may want to reconsider hanging wet clothes in the touring coach to dry.
- In hot weather, start the AC early as it removes excess humidity from the air while lowering the temperature.
- Keep the temperature as reasonably cool during cold weather as possible. The warmer the vehicle, the more cold exterior temperatures and warm interior temperatures will collide on wall surfaces, thus creating condensation.
- Use the ceiling vent to keep air circulating inside the vehicle so condensation and mildew cannot form in dead air spaces. Allow air to circulate inside closets and cabinets (leave doors partially open). Please keep in mind that a closed cabinet full of stored goods prevents circulation and allows the exterior temperature to cause condensation.
- The natural tendency would be to close the vehicle tightly during cold weather. This will actually compound the problem. Simply put, you need to remove some of the warm air and allow some cool outside air to get inside the vehicle so the furnace will not recycle the humid interior air.
- Minimize the use of incandescent lights, which produce heat and contribute to condensation.

About Molds

What are molds

Molds are microscopic organisms that naturally occur in virtually every environment, indoors and out. Outdoors, mold growth is important in the decomposition of plants. Indoors, mold growth is unfavorable. Left unchecked, molds break down natural materials, such as wood products and fabrics. Knowing the potential risks is important for any type of homeowner to protect their investment.

General Information

What factors contribute to mold growth

For mold growth to occur, temperatures, indoor or outdoors, must be between 40°F and 100°F and also, there must be a source of moisture, such as humidity, standing water, damp materials, etc. Indoors, the most rapid growth occurs with warm and humid conditions.

How can mold growth be inhibited

By controlling relative humidity, the growth of mold and mildew can be inhibited. In warm climates, use of the air conditioner will reduce the relative humidity. Vents are located in the bathing and cooking areas and constant use is advised during food preparation and bathing, even during colder weather. Additionally, opening a window during these activities will assist in ventilation. In extremely humid conditions, the use of a dehumidifier can be helpful. If using a dehumidifier, please read and follow all manufacturer instructions and recommendations to the use and cleaning of the dehumidifier.

Frequent use of your touring coach or cleaning regularly is an important preventive measure. Further, any spills should be wiped up quickly and dried as soon as possible. Avoid leaving damp items lying about. On safe surfaces, use mold or mildew killing cleaning products. Check sealants regularly, and reseal when necessary to avoid water leaks. Proper preventive maintenance to the touring coach and its accessories, as described both in this manual and in accompanying literature, will provide the best protection to the touring coach.

Waste Water System

The main parts of the waste water system are the toilet, holding tanks, and tank dump valves (see Section 9 - Maintenance for dump valve information). The system is designed to provide complete self-contained toilet facilities, while on the road or parked, without being connected to a sewage line. It may also be used when parked while connected to a sewage hose.

Keep the dump valves closed with either method and empty the tanks when they are nearly full. The idea is to send a large volume of water through the tanks and hose at the same time to float solids away.

After the sewage tank has been emptied, close the dump valves and charge the tank by putting a few gallons of water in the sewage holding tank using the black tank flush inlet. This will spray the interior of the tank with water and help prevent solids from building up in the sewage holding tank. The addition of a deodorizing agent like Aqua-Kem will help prevent odors.

Should you ever have a buildup of solids, close the valves, fill the tanks about 3/4 full with fresh water, drive a distance to agitate the solids, and drain the tanks.

Things Not to Put into Toilet or Drains

- Facial tissues and feminine hygiene products (they do not dissolve like toilet paper).
- Automotive antifreeze, ammonia, alcohols, or acetone.
- Table scraps or other solids that may clog the drains.

Drain System

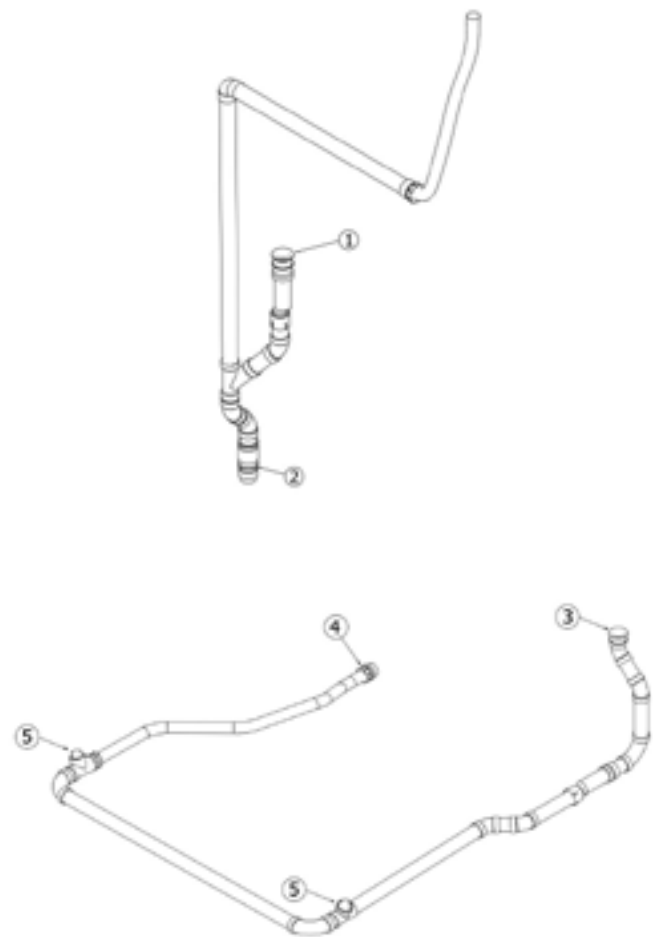

1. Lavatory Sink strainer
2. Gray Water Tank
3. Galley Drain
4. Gray Water Tank
5. Clean out tee

Winter Traveling

Traveling in sub-freezing temperatures will require certain precautions to protect the plumbing system and your personal belongings from being damaged by freezing.

While traveling, simply use your common sense. How cold is it? How long will it be before you can turn the heat back on? Is the temperature dropping or rising? Remember, when driving at 50 MPH, the wind chill factor will cause the interior of the touring coach to cool much faster than a touring coach that is parked.

1. You should have a plentiful supply of fuel as the heat from the furnace warms the touring coach and keeps the fresh water lines and black water holding tank from freezing.
2. If your stay is longer than overnight, you should endeavor to have 120-volt electricity available. Of course, you can run your generator to recharge the battery, or even use the generator continually, keeping an eye on your generators fuel. Since the generator starts off the house battery, it is recommended to start the generator prior to running the batteries down.
3. Minimize use of electricity if 120-volt power source is not available.
4. Leave cabinet doors, wet bath doors, and wardrobe doors slightly open at night to allow circulation of air in and around all components.
5. Save 12-volt power by using non-toxic RV-approved antifreeze in the gray water holding tank instead of the heating pad to prevent freezing. Quantity of antifreeze needed will vary with ambient temperature and the amount of liquids in tank.
6. For extended stays in cold weather, insulate all water lines outside the touring coach. You should remember that low temperatures in combination with high winds cause an equivalent chill temperature much below what your thermometer is reading. For instance, with an outside temperature of zero degrees, and the wind velocity of 10 miles per hour, the equivalent chill temperature is -20°F.
7. Remember to remove and drain the exterior shower faucet to prevent freeze damage.

Heated Tanks



The touring coach has 12-volt heat pads installed with the fresh and gray water tanks to help prevent freezing. The tank pads can be controlled by the main Multiplex control panel located near the side entry door or the one above the TV. On your multiplex screen, press “control” to get to the main control list. Scroll down to the bottom to find “Tank Heaters”. When the outside temperature is near freezing, simply switch “ON” the holding tank heaters. Built-in sensors will activate the heat pads when the contents of the tanks drop to 44°F. Once the liquid is heated and rises to 64°F the heat pads will automatically deactivate. Switch the power “OFF” when the ambient outside temperature remains above freezing or if the tanks are empty. The tank heaters will quickly deplete the house batteries unless the unit is plugged into an external AC power source or the generator is ran to operate the inverter/charger. To conserve battery power, RV antifreeze may be used to protect the gray and black tanks.

NOTE

The black tank is installed above the floor where heat from the furnace will keep it from freezing.

NOTE

Drain and winterize all models if the water systems are not being used during winter traveling. Refer to Section 9 - Maintenance in this manual for winterizing instructions.



Section 4

FLOOR PLANS AND SPECIFICATIONS

FLOOR PLANS	4-2
Interstate 19	4-2
SPECIFICATIONS	4-3
Specification Chart	4-3
Specification Tags	4-4
Tire Size with Maximum Inflation Pressure Cold	4-4

Floor Plans And Specifications

Floor Plans

Interstate 19



Specifications

Specification Chart

NOTE

All product information and specifications listed are as accurate as possible at the time of printing. Since we continually strive to improve our products, all specifications are subject to change without notice. All capacities are approximate and dimensions are nominal and are checked and updated throughout the model year.

Interstate Nineteen Series		
Model	All Models	4 x 4 Option
Chassis	Mercedes-Benz® Sprinter 2500	Mercedes-Benz® Sprinter 2500
Engine	Mercedes-Benz® 3.0L V6 Turbo Diesel	Mercedes-Benz® 3.0L V6 Turbo Diesel
Emissions	BlueTEC SCR Technology, 50 States - EPA/ CARB Standards	BlueTEC SCR Technology, 50 States - EPA/ CARB Standards
Horsepower/Torque	188 HP/325 lbs Torque	188 HP/325 lbs Torque
Transmission	7 Automatic	7 Automatic
Axle Ratio	3.92	3.92
Wheelbase	144"	144"
MPG*	18+ Estimated Highway	18+ Estimated Highway
Exterior Overall Length	19'5"	19'5"
Exterior Overall Height	9' 7" (with A/C & Antenna)	9' 7" (with A/C & Antenna)
Exterior Overall Width	6' 7"	6' 7"
Interior Height	6' 2"	6' 2"
Interior Width	5' 8"	5' 8"
GVWR	9,050 lbs	9,050 lbs
GCWR	13,930 lbs	13,930 lbs
UBW	7,385 lbs	see vehicle sticker for optional equipment
NCC	1,664 lbs	see vehicle sticker for optional equipment
Tow Capacity	Up To 5,000 lbs	Up To 5,000 lbs
Fuel Tank	24.5 gallon	24.5 gallon
Fresh Water Capacity	18 gallon	18 gallon
Gray Water Tank	16 gallon	16 gallon
Black Water Tank	9 gallon	9 gallon
LPG	8.2 gallons (34.7 lbs) 80% Fill	8.2 gallons (34.7 lbs) 80% Fill
Truma Combi Eco Plus Hot Water	2.6 Gallon	2.6 Gallon
Air conditioner	13,500 BTU	13,500 BTU
Furnace	14,300 BTU	14,300 BTU
Refrigerator w/Freezer Box	3.2 CU FT Refrigerator .25 CU FT Freezer 12V	3.2 CU FT Refrigerator .25 CU FT Freezer 12V
Microwave	.7 cubic feet	.7 cubic feet
Cooktop	2 Burner with Integrated Cover	2 Burner with Integrated Cover
Generator (LPG)	2.5 kW	2.5 kW
Batteries (House)	(2) 100AH Lithium with built-in heater	(2) 100AH Lithium with built-in heater
Converter/Inverter	50-Amp Charger, 1,000 Watt Inverter	50-Amp Charger, 1,000 Watt Inverter
Shore Power	30-Amp/120-Volt Service	30-Amp/120-Volt Service
Solar Power	(200 Total Watts - House) (50 Total Watts - Chassis)	(200 Total Watts - House) (50 Total Watts - Chassis)
Front and Rear Parking Sensors	Standard	Standard
Bed Size (Rear Lounge)	66" x 73"	66" x 73"
Airstream Warranty	3 Years/36,000 Miles	3 Years/36,000 Miles
Mercedes-Benz® Warranty	3 Years/36,000 Miles	3 Years/36,000 Miles
Mercedes-Benz® Engine Warranty	5 Years/100,000 Miles	5 Years/100,000 Miles

Floor Plans And Specifications

The Unit Base Weight (UBW) and Net Carrying Capacity (NCC) weights listed in the Specification Chart are for the base unit with LP and batteries included.

Gross Vehicular Weight Rating (GVWR) is the maximum permissible weight of this touring coach when fully loaded. It includes all weight at the touring coach axle(s).

UBW is the dry weight of the base unit without options.

NCC is equal to GVWR minus UBW. Gross Axle Weight Rating (GAWR) is the value specified as the load carrying capacity of a single axle system, as measured at the tire-ground interfaces.

Specification Tags

For precise cargo capacity, refer to the Cargo-Carrying Capacity tag on the inside of the door. The **WEIGHT OF CARGO SHOULD NEVER EXCEED** numbers shown on the tag, which is the maximum weight of cargo you can load and carry in your specific touring coach as built with its options.

Located on the driver's door jam of your touring coach are the Tire and Loading, and Vehicle Manufacturing tags.

The Tire and Loading information tag lists the Size and Cold Inflation Pressure of the tires on your vehicle, the weight of your touring coach as manufactured, and the GVWR.

The Vehicle Manufacturing tag lists the size of tires and wheel rims, maximum cold inflation pressures, the Vehicle Identification Number (VIN), and GAWR.

For a complete list of capacities, see the Specifications Chart on the previous page.

TIRE AND LOADING INFORMATION RENSEIGNEMENTS SUR LES PNEUS ET LE CHARGEMENT			
The weight of cargo should never exceed 744 kg or 1641 lbs. Le poids du chargement ne doit jamais dépasser 744 kg or 1641 lbs.			
TIRE PNEU	SIZE DIMENSIONS	COLD TIRE PRESSURE PRESSION DES PNEUS À FROID	SEE OWNER'S MANUAL FOR ADDITIONAL INFORMATION VOIR LE MANUEL DE L'USAGER POUR PLUS DE RENSEIGNEMENTS
FRONT AVANT	L7215/85H16J3K	420 kpa (61 PSI)	303528
REAR ARRIÈRE	L7215/85H16L3K	420 kpa (61 PSI)	
SPARE DE SECOURS	L7215/85H16J3K	420 kpa (61 PSI)	
The factory manufactured weight of this motor home is 4259 kgs (9389 lbs). The GVWR of this motor home is 5,003.00 kgs (11030 lbs).			

MOTOR HOME OCCUPANT CARGO CARRYING CAPACITY VIN:1B29H1WH29EJ303528 THE COMBINED WEIGHT OF OCCUPANTS AND CARGO SHOULD NEVER EXCEED 744 kg OR 1641 LBS Safety belts equipped seating capacity : 9 CAUTION: A full load of water equals 112 kg or 249 lbs of cargo at 1kg/l. (8.33lb/gal)

NOTE

Specification tags shown are examples only.

Tire Size with Maximum Inflation Pressure Cold

Front Tires: LT245/75R16 - 47 psi

Rear Tires: LT245/75R16 - 70 psi



WARNING

For safety reasons, the wheel tightening torque must be checked immediately after changing a tire and again after 30 miles to 140 ft-lbs. The wheels could otherwise come loose.

Section 5

INTERIOR

GENERAL INFORMATION AND CLEANING	5-3	Multiplex System	5-8
Ultra Leather	5-3	Systems Controlled By CZone®	5-8
PermaBlok3® by Spradling	5-3	Monitor Panel	5-8
Cabinets and Overhead Lockers	5-3	Menu	5-8
Aluminum Interior Skin	5-3	Favorites	5-8
Counter Area	5-3	Power Center	5-9
Sinks	5-3	Auxiliary Fuse Locations	5-9
Vinyl Flooring	5-4	Energy Management System (EMS)	5-10
Polishing the Flooring	5-4	Circuit Protection	5-10
Privacy Sun Shades	5-4	Operation	5-10
Wet Bath	5-4	Display Panel	5-11
Shower Head	5-4	Service	5-11
Retractable Clothesline	5-4	Status	5-11
Toilet	5-4	Generator	5-11
Deodorizers and Biological Chemicals	5-4	Automatic Generator Start (AGS)	5-11
Faucets	5-5	120-Volt Power	5-12
Lavatory Faucet	5-5	120-Volt Automatic Switch Over Box	5-12
Galley Faucet	5-5	Generator/City Power	5-12
Faucet Cleaning and Care	5-5	Battery Disconnect Switches	5-13
Storage	5-5	Manual Disconnect Switch	5-13
Driver and Passenger Seats	5-5	DC-DC Battery Converter	5-13
Powered Side Ottomans	5-6	Protecting the Charging System	5-13
Rear Lounge/Bed	5-6	Inverter/Charger	5-14
Table System	5-6	Converter	5-14
Power Shades	5-6	120-Volt System	5-15
ELECTRICAL	5-7	City Power	5-15
12-Volt System	5-7	Ground Fault Circuit Interrupter	5-15
12-Volt Operation	5-7	GFCI Breaker Test	5-15
Ceiling and Directional Lighting	5-7		

Section 5 Interior

ENTERTAINMENT SYSTEMS5-16	APPLIANCES5-17
Digital Media Player5-16	Maintenance5-17
Subwoofer5-16	Air Conditioner5-18
TV5-16	Heat Pump5-18
TV Antenna5-16	Cooktop5-18
Cleaning Antenna Housing5-16	Ceiling Vent Fan5-18
TV Wall Plate Power Supply5-16	Thermostat and Rain Sensor5-19
Operation5-16	Cleaning Instructions5-19
Antenna Pre-Wiring5-17	Exhaust Fans5-19
Roof Mounted Satellite5-17	Furnace and Water Heater5-19
Portable Satellite Antenna5-17	Selectable Modes Of Operation5-20
Connected RV Antenna Pre-Wire5-17	Truma Combi CP Plus Control Panel5-20
		Microwave Ovens5-20
		Monitor Panel5-21
		To Read a Water or Sewer Tank Level5-21
		To Read the Battery Voltage5-21
		Refrigerator5-22
		Operation5-22
		Defrost and Cleaning5-22
		Solar System5-22

General Information and Cleaning

The interior of each Airstream Touring Coach has been designed for comfort, convenience, durability, and appearance. How you use it and how you take care of it, naturally, depends on you. However, if you learn to operate the interior components and take care of them and the touring coach properly, this knowledge will add to your pleasure, as well as the long life of your touring coach. All material should be professionally dry cleaned to remove any overall soiled condition.

Ultra Leather

Spot clean regularly with mild soap and water. For stubborn stains, wipe with isopropyl (rubbing alcohol) as soon as possible. Sanitize using a disinfectant such as a 5:1 water/bleach solution. Air dry or dry quickly with a hair dryer on warm setting.

NOTE

Never remove cushion covers for separate dry cleaning or washing. Any tumble cleaning method can destroy the backing, and/or shrink or otherwise damage upholstery fabric.

PermaBlok³® by Spradling

PermaBlok³® is a vinyl protective coating that's engineered to create a tough, effective barrier against the three biggest problems: germs, abrasion, and stains. You can not see it or feel it, yet the protection it offers results in extended performance and lasting beauty with minimum care. Most stains can be removed with a damp cloth and cleaned with a 1:1 mix of Ivory[®] soap and water. A 1:1 mix of ammonia and water, or a 1:4 mix of bleach and water can be used for more stubborn stains. Only if needed a 1:1 mix of isopropyl alcohol and water can be used. Use only a soft cotton cloth and rub the stain in a circular motion. Rinse thoroughly with clean water and pat dry.

Cabinets and Overhead Lockers

The furniture is manufactured from a high-pressure laminate and can be cleaned with soap and water, or you can use a common solvent on tough spots. Furniture polish can be used sparingly. Plexiglass doors must be cleaned with a anti-static cleaner and cloth. Windex or common ammonia products will damage the coating on the surface.

NOTE

Do not use any abrasive material, abrasive cleaners, cloths and pads as there is the possibility they could scratch the surface.

Aluminum Interior Skin

The metal interior skin on the ceiling is coated with a baked-on acrylic coating. Use soft rags or wash mitts always moving lengthwise with the grain of the aluminum. NEVER rub hard on the coating. Oil, grease, dust, and dirt may be removed by washing with a 5 percent solution of commonly used commercial and industrial multi-purpose detergent in water. Cleaning should be followed by a thorough clean water rinse. Drying the metal with a chamois or a soft cloth may prevent spots and streaks. When washing or waxing the metal, always wipe "with" the grain of the metal. A good grade of nonabrasive automotive paste or liquid wax once a year will increase the life of the finish.



CAUTION

Abrasive polishes or cleaning solvents such as automatic dishwasher or acid etch cleaners are too strong and should never be used. Rinse all grit from surface prior to washing. Use soft rags always moving lengthwise with the unit. NEVER rub with excessive pressure on the coating. Even the softest rag will damage the coating if excessive pressure is applied.

Counter Area

Your Airstream is equipped with Corian[®] countertops which can be cleaned with common household cleaners. For most residues use warm soapy water or an ammonia-based household cleaner; rinse and wipe dry. For stubborn residue spray with *Deep Cleaner from Stone Care International*; wait 30 seconds and wipe dry with a paper towel. For disinfecting occasionally wipe the surface with a solution of 5Tbsp. Bleach/1 gallon water mix. Rinse top thoroughly with water and wipe dry.

Sinks

Cleaning can be accomplished using a mild liquid detergent on a soft cloth. A complete home owner's guide for your sinks is supplied in your owner's packet. Please read these instructions before use.

Vinyl Flooring

Use a soft broom to sweep the floor. A vacuum cleaner may damage the flooring, especially the type that use beater bars. In most cases, a clean damp cloth or mop will suffice to clean dirty flooring. When necessary, a solution of mild detergent or domestic floor cleaning emulsion can be used to clean the flooring. Do not use a wire brush or nylon scouring pads, furniture polish, spirit-based polish, powder or liquid abrasive cleaners, bleach or other strong detergents. Scuffs, dirt, and spillages should be cleaned up as soon as possible.

Rubber backing on doormats may result in yellow discoloration of the floor immediately beneath. Choose a natural fiber mat. Mats provided by Airstream are intended for use outside of the touring coach. Rubber feet on furniture may cause staining. Remove them altogether or place coasters or felt pads between them and the floor.

Polishing the Flooring

Cushioned floors that have an additional protective coating such as Beauflor Premium Protect, Multi Protect and Ultragrip, do not normally require polish. Other floors (Bartoli/Lioni) will require polishing to protect the floor's surface from staining agents and give a surface shine. For these, apply a liquid emulsion floor polish immediately after installation and thereafter at 6 to 12 monthly intervals as required. Always follow the manufacturer's instructions when using a floor polish or cleaner and ensure it is suitable for use with cushioned vinyl flooring.

Privacy Sun Shades

Privacy shades are provided for the front windshield and driver/passenger cab windows. The shades have magnets sewn into them that attach to the van.

Light brushing with an upholstery brush or gentle use of a vacuum cleaner will suffice in most situations. For heavy soiled conditions dry clean only. Washing the shades may void the warranty.

Wet Bath

To clean your fiberglass shower stall unit, use warm water and a liquid detergent. Do not use abrasive cleaners; they may scratch and dull the surface of your fiberglass unit. Stubborn stains can be removed with solvents such as turpentine, paint thinner, or acetone. Restore dulled areas by rubbing with an automotive-type liquid cleaner, and then put the soft glow back into the sides of your unit with a light application of liquid wax. DO NOT wax the shower bottom as it may become slippery leading to a fall.



CAUTION

Applying wax to the base of the shower floor is not recommended, as this could create an unsafe surface.

Shower Head

The shower head is designed to give maximum flexibility in usage, and provides for water-saving techniques when using your touring coach on self-containment. It can be held in the hand and moved about the body. Normally, the best water conservation procedure is to wet the entire body and then turn the water off. Apply soap, lather thoroughly, and then rinse the soap off.

Retractable Clothesline

A retractable clothesline is installed for your convenience in the shower stall. To use, pull the line from the base and attach it to the holder on the opposite wall. Turning the nut on the base will tighten the line.

Toilet

The toilet in your Airstream is a design that has been used for many years.

To flush, press the foot pedal, holding the pedal down until all solids have cleared. To add water into the bowl, press the pedal down halfway.

NOTE

When you dump the bowl of the toilet, make sure all paper and solids have cleared the slide mechanism before you allow it to close. Failure to do so can cause the groove for the slide to become jammed and the slide will no longer close completely.

Please see the toilet owner's/user manual for warranty and user tips, and maintenance information.

Deodorizers and Biological Chemicals

There are many deodorizers and processing chemicals on the market in tablet, liquid, and powder form. These not only combat odor, but also stimulate the bacteria that works to dissolve the solids and tissues in your waste tank. These chemicals should be introduced through the toilet prior to use per the manufacturers directions. It's also important to always add a few gallons of water by filling the toilet bowl a few times and depressing the foot pedal.

Faucets

Lavatory Faucet



Airstream Part #602251

ITC, Inc. - Model 8W0619CP

Galley Faucet



Airstream Part #602849

Moen - Model 7565SRS

Faucet Cleaning and Care

All that is needed to clean your faucet is a soft, damp cloth. Airstream does not recommend the use of scour pads, cleansers, or chemicals. The abrasive nature of these substances could damage the faucet's finish. A non-abrasive car wax will help to protect the finish.

Storage

Galley cabinets should have the heaviest items stored on the bottom and lighter items overhead. After loading, put skillets and canned goods on the floor or bottom shelf, and cereals and crackers in the overhead roof locker. Use unbreakable-type plates and saucers, and consider storing your dish towels around them.

Clothes hung in wardrobes should be kept on hangers that snap over the clothes rods to keep them from bouncing off on rough roads. Try to avoid large bulky coats. Layers of lighter clothing will usually keep you warmer, are more versatile, and are easier to store.



WARNING

Keep flammable material away from the furnace.

Driver and Passenger Seats

The driver and passenger seats are provided by Sprinter, sent out to be recovered by Airstream to match the interior decor.

The seat adjustment mechanism provided by Sprinter allows the seat to be moved forward or backward and swivel left or right. Buttons near the door handle are used to move the seat forward and backward. Pressing down on the handle, centered under the front of the seats, allows the seat to swivel. Return the seat to the full upright position before using the swivel adjustment. The heated seats are activated by switches located on the door, next to the seat controls. For complete details on seat adjustments, please refer to the Sprinter manual.



WARNING

Adjust the driver's seat so that you can easily reach and operate all controls. Make sure the seat is locked in position. Do not adjust driver's seat swivel or fore and aft mechanism while vehicle is moving. The seat could move unexpectedly causing loss of control.



CAUTION

Seat backs in cab must be returned to full upright position and seat moved forward before seat is swiveled. Failure to do so could result in damage to the seats upholstery, the wall panels, and the seats decorative skirt.

Powered Side Ottomans



The powered ottomans on each side of the coach are powered by the rocker switches on the end of the roof locker. These can be adjusted to create sleeping areas and to access components. The passenger side can be moved to access the water pump and the driver's side can be moved to access areas of the Truma system.



WARNING

Side Ottomans are not to be used as seating while in motion as there are no seat belts available.

NOTE

Operate ottomans and sofa separately to avoid tripping the thermal breaker. If breaker is tripped, wait until it resets and operate one at a time.

Rear Lounge/Bed

The rear sofa and side ottomans can be converted into a sleeping area by first pulling off the detachable back rests on the Ottomans and ensuring table is stowed. Press and hold the switches located on the passenger side overhead storage locker until the lounge and ottomans flatten completely. Make sure to completely stow the galley extension.



WARNING

Keep your furniture and family safe from fires caused by careless smoking. Do not smoke when drowsy. Remove immediately any flowing ash or a lighted cigarette which falls on furniture. Smoldering smoking material can cause upholstered furniture fires.

Table System



The touring coach is equipped with a removable table which is stored behind the driver's seat. To remove from the mount, move driver's seat up towards the steering wheel for clearance. Loosen the knob at the top of the table and rotate bracket. Pull table out being careful not to damage the table or the paneling. Turn table over and remove table leg by loosening handle and sliding off of table. Insert table leg into the leg holder at the rear sofa and adjust to desired height. Install table top onto leg and tighten to desired position. Reverse operation for storage.



WARNING

Return table top to their proper storage positions before moving the vehicle. In a emergency stop or accident the table could cause personal injury and/or death.

Power Shades

All Interstate 19 models come with power shades controlled by the Multiplex System control panels located in the front and rear of the touring coach. The shades feature a mechanical limit switch to prevent accidental loss or change of limits due to power surges or power outages. The shades will retain their pre-set limit stops even if the shade is pulled down manually by mistake. These presets are set at Airstream and shouldn't need adjusted.

The multiplex panels allow for control over individual shades as well as a master control button to raise or lower all the shades at once. Pressing the shade you want to control, and then either the up or down arrow to raise or lower the shade. If the same arrow is pressed before the shade reaches its pre-set limit stop the shade will stop at its current position.

Refer to the Power Shades owner's manual for tips on cleaning.

Electrical

12-Volt System

The major portion of electrical power in your Airstream is 12 volt. The 12-volt current powers almost every thing except the roof A/C, water heater, 120-volt receptacles, and microwave oven. However, some of these appliances have 12-volt electronic boards.

All 12-volt current is routed to a 12-volt fuse block. The fuse block is the hub of the 12-volt system tying together the inverter/charger and house batteries.

Power from the fuse block goes to a buss bar holding Type 2 thermal breakers. The thermal breakers then feed electrical components throughout the touring coach. One of the thermal breakers is fed by the house solar controller, providing some supplemental power, under ideal weather conditions.

Power is routed from the battery disconnect to the 12-volt distribution panel and through its branch circuits to the rest of the touring coach.



CAUTION

Thermal breakers break contact when overheated by a short or overload in the wiring. These breakers automatically reset when cooled down. A breaker continually overheating and breaking contact should be investigated by a qualified service technician.

12-Volt Operation

The only thing you have to do is make sure the house batteries do not run down. This should not be an issue if you are plugged into an external AC power source at night or when camping. When you're plugged into shoreline power, or running the generator, the converter charges the batteries and carries much of the load.

Some nights you may not find a place to plug into city power. This should not be a problem as well; you can continuously run your interior lights, water pump, and vents for about 8 hours on a full charge. However, you should monitor your battery voltage and start the generator, if needed. Fully charged house batteries will provide approximately 8 hours of moderate 12-volt usage. If the inverter is being used extensively the house batteries will be depleted much quicker.

If you are not plugged into city power, and you plan on staying longer than a day or two, you will want to conserve your batteries by using as few lights and appliances as possible. Check the monitor system regularly. It's much easier on the batteries if you start the generator or run the chassis engine before the batteries run down. The generator starts from the house batteries so it must be started before they are depleted. If the house batteries become depleted, the chassis engine can be started to charge them. It could take a few minutes before the house batteries are charged enough to start the generator.

The engine battery and house batteries are isolated from each other by a DC-DC converter, preventing the two systems from drawing down simultaneously.

Ceiling and Directional Lighting

All lighting in the Airstream Interstate Nineteen is LED and most will require a replacement fixture should it go out or malfunction. Lighting can be operated from the two control panels connected to the Multiplex System. The main touch screen control panel is located just inside of the main entry door. The Circuit Control Board is located below the curbside jumper seat. There is another main touch screen at the back of the coach above the TV.

The Multiplex System is self resetting should a circuit trip. The system should never need reset by the owner for any reason. If the main control panel or remote panels are not operating this could indicate a short in the wiring and should only be serviced by a certified technician.

Interior

Multiplex System

The Multiplex System provides advanced automation and mobile electrical solutions for your touring coach. CZone® is a multiplex network system designed to combine multiple signals across a media to reduce wires and simplify end user control. The system combines all desired functions and controls of the touring coach into a central location.

Mode buttons allow for a single press of the button to control several features of the trailer. Away mode turns off the lights and lowers shades to prepare for departure. Onboard mode will turn on lights and lift shades

Systems Controlled By CZone®

- All lights (inside and outside)
- Power awning and awning lights
- Shades
- Roof vent
- Climate
- Generator
- Tank monitoring (Fresh, Black, Grey and LPG)
- Battery voltage
- Tank heaters
- Water pump

Monitor Panel



The “Monitoring” screen of the Multiplex System control panel displays the fluid levels of the Black Water, Grey Water, Fresh Water, and the LP gas tanks. The panel also shows the voltage status of the main (chassis) and the auxiliary (house) batteries.

The fluid monitoring system has been calibrated at the factory for the size tanks the touring coach uses and, therefore, should never need another calibration.

Menu



Pressing the “Menu” button, located at the top left corner of the touch screen, accesses the CZone® sub menus. This Menu will provide the user controls and information ranging from lights and temperature controls to alarms and notifications.

NOTE

When dimming it is normal for LED lights to flicker. Lights should return to normal once they are set to a desired brightness.

Favorites

The CZone® default screen display is the favorites page. There are multiple favorites pages represented by the dots near the bottom of the touch screen. Swiping left or right will move to the next page. The favorites pages provide quick access to the most commonly used features.

1. The first favorites pages displays controls for the interior and exterior lights and the different modes available. Tap the icon to turn ON or OFF the desired light. Some lighting may be dimmable and can be adjusted by touching and holding the icon for two seconds. A secondary screen will appear allowing you to slide UP or DOWN to adjust the brightness



- Swiping left on the screen will display controls for the shades, Water pump, Vent fan and Awning. The shade controls can be used to RAISE or LOWER all the shades at once. Pressing the icon a second time before the shades reach their preset limit will stop the shades at their current position.



- Page 3 of favorites contains the controls for air conditioning unit. The AC units can be turned ON or OFF or can be switched between different modes



Power Center



The power center is installed at the base of the passenger side power ottoman. Open the decorative door for access to 12-volt fuses and 120-volt breakers.

The power center is a completely self-contained 120-volt power distribution and energy management system intended to be used in recreational vehicles. It is housed in a sheet metal enclosure with a removable front panel. It provides circuit protection for all the 120-VAC loads in the touring coach and works with the Energy Management System to minimize the overloading and tripping of circuit breakers.

Refer to Section 9 - Maintenance for important battery maintenance information.



WARNING

The power center is a centralized power switching, fusing, and distribution center. The potential of lethal electrical shock is present in this box. Inadvertent shorts at this box could result in damage and/or injury. All servicing of this box should be done by a qualified Service Technician.

Auxiliary Fuse Locations

In addition to the 12-volt fuses and breakers described in this section, some components have additional fuse protection as supplied or required by their manufacturer. These locations include:

- LP detector: 2-amp fuse behind detector
- DC-DC Battery Converter: 150-amp in-line fuse inside Sprinter battery compartment under the driver's floorboard
- Monitor panel battery voltage display: under the roadside jumper seat. (1 amp)
- Inverter: 150-amp in-line fuse under the sofa on the roadside.
- Rear view camera: 1.5-watt in-line fuse under drivers seat. (#11 fuse)

NOTE

Most fuses will require a qualified technician to access and replace. Contact your dealer or Airstream Service Center.

Energy Management System (EMS)

The Energy Management System is located in the rear roof locker above the TV. A complete, detailed EMS manual is included with your owner's packet.

The ENERGY MANAGEMENT SYSTEM controls 120-volt operated circuits to help keep the total 120-volt current draw to less than 30 amps. When operating on generator power the 120-volt draw will be less than 20 amps. These circuits may be any type load, but are typically heavier loads, those whose use can be "postponed" until a time when current is available for their use.

Circuit Protection

Circuit protection for ALL 120 VAC loads are standard residential resettable circuit breakers install in the Power Center (120 VAC section). Airstream has pre-installed the correct breakers per RVIA (NEC) listing requirements for the touring coach. The MAIN breaker for the touring coach is 30 amp and feeds the branch-breakers in the breaker box. Shutting off the MAIN breaker will remove power to all branch loads, except for receptacles on the Inverter circuit when the inverter mode is "ENABLED". The Inverter/converter contains a resettable 20 amp input breaker and a 15 amp output breaker. The remaining power center branch-breakers feed individual loads and are defined by the label affixed next to the breakers. The source for 120 VAC power to the power center can come from either the shoreline plug when connected to a camp site or the touring coach's generator, when running. If plugged into shoreline power, and the generator is started, the power feed to the power center will be coming from the generator.

The main and general load branch-breakers are operated similar to a light switch with up as "ON" and down as "OFF". If an overload condition or a short occurs the switch will snap to the "OFF" position. The load for this breaker will now be "OFF". Before resetting the breaker be aware of any device that may have been plugged in or turned "ON" which may have cause the breaker to overload. Unplug or turn "OFF" the possibly faulty device before resetting the breaker. To reset the breaker, you will need external AC power going to the breaker box (shoreline or generator), then firmly push the breaker switch to the "OFF" position then back to the "ON" position. If the breaker snaps back to the "OFF" position while resetting, a fault condition still exists and should be serviced by a qualified Service Technician. If the breaker stays "ON" but snaps back to "OFF" after plugging in or turning ON the possibly faulty device a fault condition may exist in that device and should be service by a qualified Technician.

The power center Ground Fault Interrupt Circuit (GFIC) breaker is a special breaker that will provide additional safety to the occupants of the touring coach on the following receptacles; external, galley, lavatory, and entertainment. In addition to short circuit and overload protection the GFIC will shut off the breaker if any current feeding out of the breaker does not return to it. As in the case of a person contacting the electrical energized part of the GFIC circuit and an electrically conductive object not associated with the circuit.

Refer to to Ground Fault Circuit Interrupter and GFCI Breaker Test in this section for more information.

Operation

In operation, when 120 VAC and 12 VDC are initially applied, the system will energize the relays at one second intervals, closing the normally open contacts on each of the relays while monitoring the total current. If the total should exceed the service limit, the system will turn off the last load that was turned on. As it does this, it calculates the amount of current that was removed, which is the value for that load. This value is placed in memory. The system has "learned" the amount of current that particular appliance draws. This feature compensates for the difference in current draw over a range of line voltage and ambient temperature, by relearning the load each time it is turned off.

The system now waits until the total current is lower than the service limit, by the amount in memory, before it will turn that load back on. This ensures that there is sufficient current to operate the load.

Display Panel



The display panel requires little user interaction and is provided to help the user understand power management. The display monitors the total AC current of the touring coach and prevents circuit breaker tripping by momentarily shedding loads. As additional appliances are turned on the system will begin to shed loads. As appliances are turned off, and a minimum of two minutes has expired, the system will automatically restore power to each of the shed loads.

Service

The “Select” button allows the service type to be set to either 15, 20, or 30 amps to match the incoming service.

When power is first applied, the system will be in the 30 amp mode and the screen will display “Service 30A”. Momentarily pressing the “SELECT” button will switch the system to the 20 amp mode. Momentarily pressing the button again will switch the system to the 15 amp mode.

Press the “SELECT” button to switch to either 15 or 20-amp service if it is necessary to use an adaptor or you know the shoreline power is 15 or 20 amps, The screen will display either “Service 15A” or “Service 20A”.

The generator supplies 20 amp service and is set to switch the system automatically to the 20 amp mode whenever the generator is the power source. The screen will display “Generator 20A” when the generator is supplying power.

Status

The roof A/C and microwave are set at the factory to be the controlled circuits and are shed in this order.

This means if a power hungry appliance is plugged into an outlet and the system begins to use more than 30-amps it will begin to shed loads and will shut off the A/C.

Generator

The onboard generator makes your RV house electrical system fully self-contained. It allows you access to 120 volts when there is no shore power available. To use the generator you simply start it. All switching is done automatically. The generator can be started from any of the Multiplex panels. It is easier on your generator and appliances if you’ll allow the generator to reach its normal operating speed (about a minute) prior to applying heavy current loads.

Do not operate the generator in an enclosed building or in a partly enclosed area such as a garage. Nor should the generator be operated while sleeping. Be sure to follow all instructions and warnings in this manual and the generator manufacturer’s manual.

Automatic Generator Start (AGS)



Your touring coach is equipped with an Automatic Generator Start System (AGS) which provides an optional automatic control of your onboard generator. The purpose of an AGS system is to automatically start (and run) the generator when the 12 volt electrical system (house batteries) drops to a pre-determined level. The AGS can be enabled to monitor the house battery bank and when it reaches a certain level, the generator will automatically start, sending a charge to your batteries. This protects the system so that your batteries will not go down farther. Once the batteries receive a sufficient amount of charge, the generator will automatically turn off. If you are in a location for an extended period of time, this can help protect battery bank when shore power is not available. You may also have the ability to set predetermined times so that it will not start during the night or during posted quiet times in a campground.

Once enabled, AGS will remain enabled until the Sprinter Ignition is cycled or the generator is manually operated.

Carbon Monoxide (CO) is a highly poisonous gas. Moving Parts and electricity can cause severe personal injury or death. To reduce exposure to these hazards, always disable AGS before

1. Sleeping in vehicle, unless equipped with a working Carbon Monoxide detector
2. Parking vehicle in a garage or confined space
3. Parking vehicle for storage
4. Servicing generator, batteries or other electrical appliances
5. Fueling vehicle



WARNING

Exposure to carbon monoxide, moving parts, and electricity hazards are possible due to unexpected starting of generator while in Auto Start mode.

120-Volt Power

When you're plugged into shoreline power or starting your generator, 120-volt current is fed to an Automatic Switch Over Box. Power from the box runs to the 120-volt circuit breakers on the Energy Management System

NOTE

Make sure to read, understand, and follow all electrical component owner's manuals provided in the owner's packet before operating the touring coach. Observe all operating instructions and Warnings as well as all recommended maintenance schedules and procedures.

120-Volt Automatic Switch Over Box

The switch over box automatically switches the 120-volt feed to the Energy Management System Module from shoreline to generator and back as you choose which way to power the touring coach. You simply decide whether to plug into a 120-volt shoreline or start the generator and the box will do the rest. If the generator is accidentally started while plugged into shoreline the box will sense the generator incoming power, contact points inside the box will switch cutting the shoreline connection, and establishing the generator connection. This protects the system from a possible overload from dual power sources.

Generator/City Power

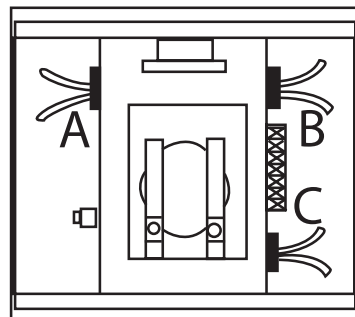

- a. To Energy Management System module main breaker
 - b. From generator
 - c. From shoreline
1. When plugged into shoreline power, the current path is from C to A.
 2. When you start your generator, the points switch and the power flow is from B to A. Stopping the generator releases the points back to shoreline feed.
 3. If you're plugged into shoreline and you start the generator, the points still switch since the generator has the priority, so the current flow is still B to A.

NOTE

Make sure to read and understand all electrical Component owner's manuals provided in the owner's Packet before operating the touring coach. Observe all operating instructions and Warnings as well as all recommended maintenance schedules and procedures.

Battery Disconnect Switches



The battery disconnect switch located by the entry door is used to separate the 12-volt distribution panel from the converter charging system. You can also operate the battery disconnect through the “Control” menu on the Multiplex panels. When connected to an external AC power source, the 12-volt distribution panel will receive power from the converter and the touring coach will function normally. The batteries will be charged through the converter charging system regardless of if the battery disconnect switch is in the ON/OFF position.

If the touring coach is NOT plugged into an external AC power source and the switch is turned to OFF the batteries are disconnected and the 12-volt distribution panel will not receive power from the converter. The converter will not charge the batteries with the switch in the OFF position with no shoreline power present. The OFF position is intended for storage of the touring coach or when power conservation is desired.

The solar panels will charge the batteries regardless of the battery disconnect switch position. Likewise, if ON or OFF, the generator will charge the batteries.

NOTE

As a safety precaution, the electric gas shut-off solenoid closes automatically when 12-volt power is disconnected, cutting gas to appliances. It will reopen when power is restored.

Manual Disconnect Switch



The manual disconnect switch, located behind the sofa and accessed through the rear door, is used to turn off power from the battery to the 12-volt distribution panel. Push knob in before manually rotating it to the ON/OFF position.

The manual disconnect switch can be used to completely disable the main disconnect switch by over rotating the switch in the ON/OFF positions till a click is heard. The disable OFF feature is useful for long term storage of the vehicle where the main disconnect switch could be turned on and the batteries accidentally drained. Likewise, the Disable ON feature is useful while camping when the main disconnect switch could be turned off cutting power to appliances.

The holding tank heat pads, rear lounge motor, solar panel, and generator are not connected to the 12-volt distribution panel and are wired direct in through the thermal breakers. The main disconnect will not disable these systems.

DC-DC Battery Converter

The DC-DC Battery Converter is located under the driver's seat. It is designed as a power gateway that only allows a maximum of 40 amps to pass between the vehicles alternator and the coaches converter.

Protecting the Charging System

The DC-DC Battery Converter monitors the house battery system to determine if the batteries are being charged. The charging can be accomplished through the inverter/converter or the vehicles alternator.

NOTE

In the event the engine battery is depleted, Sprinter recommends using a trickle charge only when charging the battery. When jumping the engine battery, do not use a power boost. Read and follow battery charging procedures in the Sprinter Owner's manual.

Inverter/Charger



The Inverter/Charger is a DC to AC inverter and a 50-amp multi-stage battery charger. The charger is derated to 50% (25A) for the Energy Management System. The remote control module is mounted in the rear roof locker above the TV.

The Inverter/Charger charges the batteries and converts 12-VDC to 120-VAC current for distribution to the entertainment devices. To operate your entertainment circuit the inverter must be ON, unless connected to generator or shoreline power.

If power is not needed to the entertainment circuit make sure the inverter is turned OFF to conserve battery power. The inverter will have a slight power draw even when turned off but the power consumption will be even greater if left on.

NOTE

Airstream calibrates all settings at the factory and recommends adjustments not be made.



WARNING

An extensive owner's manual for the Inverter/Charger is provided in the Airstream Owner's Packet. Make sure to read, understand, and follow all information, notes, Cautions, and Warnings in the manual before operating the Inverter/Charger.

Converter

The Airstream converter system enables you to use the 12-volt lights and equipment whether operating on self-contained battery power or hooked up to 120-volt city power. The 12-volt light bulbs give off the same light as regular household bulbs, so that when operating on self-contained battery power, everything works normally except the 120-volt convenience outlets and 120-volt appliances.



CAUTION

When operating with city power, make very certain that the service is 120 volt, not 240 volt.

The converter system is a transformer designed to maintain constant output voltages regardless of the variances that occur in city power systems. The design eliminates the need for complex electronic sensing systems to charge the batteries, minimizing the possibility of failures and greatly increasing its overall reliability.

In some older parks and other locations where three-pronged outlets are not available, certain precautions to ensure proper grounding and polarity must be taken. These precautions are listed below:

1. Attach the three-pronged plug to a two-pronged adapter. The third conductor line of this adapter has a short wire lead that must be grounded.
2. For proper grounding, connect the short ground lead to a grounded outlet box or to a cold water pipe. When no water pipe is available, drive a metal rod two feet into the ground and attach the ground lug to it, thus providing the unit with proper grounding.

NOTE

When the three-pronged plug can be used, there will be no problems with proper polarity or grounding with a properly-wired shoreline outlet.

120-Volt System

City Power

When your touring coach is hooked up to external AC power, the converter system automatically charges the touring coach batteries regardless of the battery disconnect switch position. The speed and degree of charge depends on how much power is used for lights and appliances, as only the surplus goes to charging the battery. If you are making an extended stay you should keep your touring coach hooked up to external AC power, if it is available.

While you are connected to external AC power, the wiring is protected by circuit breakers in the breaker panel. The circuit breaker panel for the 120-volt system is located in the power center. In the event of a failure of a 120-volt circuit, first check your touring coach circuit breakers and the breaker for the outlet into which your touring coach shoreline cord is plugged. If a breaker continues to trip after you have reset it several times, your circuit may be overloaded with appliances or there may be a short in the circuit. Try lessening the load on the circuit. Perhaps an electric griddle, hair dryer, or an electric heater can be turned off. If that does not solve the problem, consult an Airstream Service Center.

The 120-volt electrical system provides power to operate the A/C, converter, and 120-volt receptacles for portable appliances. The power is carried through the 120-volt city power flexible cord to the 120-volt distribution panel, and then is distributed to each appliance or receptacle. Exterior 120 volt outlets are located on the curbside.

All wire, components, and wiring methods conform to federal and state requirements.

Ground Fault Circuit Interrupter

Most states require touring coach's with exterior 120-volt receptacles and receptacles close to a water sources, such as a faucet, to have a GFCI. When properly installed, the GFCI circuit breaker provides reliable overload and short-circuit protection, plus protection from ground faults that might result from contact with a **HOT** load wire and ground.

The system incorporates GFCI breakers that implement an auto self-test functionality. When turned off, these breakers require external AC or generator power to be present before they can be turned back on. If power is present from one of these sources, and the breaker refuses to stay on consult an electrician or certified RV technician.

Each GFCI circuit breaker is calibrated to trip with a ground current of 5 mA or more. Since most people can feel as little as 2 mA, a distinct shock may be felt if the need for protection exists. However, the shock should be of such short duration that the effects would be reduced to less than the normally dangerous level. However, persons with acute heart problems or other conditions that can make a person particularly susceptible to electric shock may still be seriously injured.

While the GFCI circuit breaker affords a high degree of protection, there is no substitute for the knowledge that electricity can be dangerous when carelessly handled or used without reasonable caution.



WARNING

The GFCI circuit breaker will NOT reduce shock hazard if contact is made between a HOT load wire and a neutral wire or two HOT load wires. GFCI circuit breakers provide protection only to the circuit to which it is connected. It does NOT provide protection to any other circuit.

GFCI Breaker Test

Perform this test on the GFI circuit breaker each month and record the date.

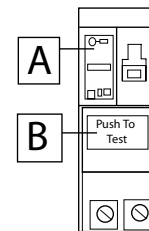

1. With handle A in "ON" position, press PUSH TO TEST button B.
2. Handle A should move to TRIP position, indicating that GFCI breaker has opened the circuit.
3. To restore power move handle A to "OFF" and then to "ON".

If the device remains on when the Test button is pushed, the GFCI is not working properly or has been incorrectly installed (wired improperly). If your GFCI is not working properly, call a qualified, certified electrician who can assess the situation, rewire the GFCI if necessary, or replace the unit.

Entertainment Systems

Digital Media Player

The touring coach comes equipped with a Fusion® Stereo which has an LCD color display. The stereo features several source options such as Bluetooth, FM radio, AUX and USB connections.

Download the Fusion-Link Remote Control App to adjust the volume, change the source, and control other functions of the stereo. See the Fusion Quick Start Manual for complete operating information.

NOTE

If the main “battery disconnect” switch does not power off the radio it will need to be turned off by pressing the power button on the radio.

Subwoofer

A dedicated volume control is installed in the overhead compartment, behind the driver’s seat. Use the control to raise or lower the subwoofer to the desired volume.

TV

The Interstate 19 Touring Coach is equipped with an LED HDTV and prewired for installation of a Blu-Ray player. Please refer to the documentation included in your owner’s packet for instructions on its use.

TV Antenna



The installed omnidirectional antenna provides excellent reception of VHF/UHF TV channels. The TV antennas compact modern styling is unobtrusive and blends well with the designs of recreational vehicles.

The amplified signal maximizes signal strength to provide the best TV reception available in your area. The antenna receives free VHF, UHF and FM signals. Manufactured with durable automotive-grade plastic, the antenna is weatherproof, UV-protected and resistant to rust.

Cleaning Antenna Housing

The antenna is constructed with an automotive-grade plastic. Clean only with mild soap and water. Use no solvents, alcohol, or cleaning fluids. Do not power wash any part of the base mount of head of the antenna.

TV Wall Plate Power Supply



The wall plate/power supply provides 12 VDC to the antenna as well as antenna signals to two TV sets. Cable input from outdoor receptacle connects to the wall plate and may be switched so either antenna or cable/satellite signals may be watched. This is located in the cubby under the TV.

Operation

To receive cable signals from the exterior inlet: Press switch to OFF position. The light on the wall plate will go (OFF) showing that power is no longer connected to the antenna and that both TV sets are receiving signals. To receive signals from the roof antenna: Press switch to ON position. The light on the wall plate will come (ON) showing that power is connected to the antenna and both TV sets are receiving signals from the antenna.

Antenna Pre-Wiring

Roof Mounted Satellite

The touring coach is pre-wired with a coax cable for a roof mounted satellite antenna. One end of the cable is coiled in the microwave cabinet and the other end is coiled behind the removable entertainment cabinet side panel where the TV booster is mounted. A receiver can be placed inside the cabinet. An HDMI cable is located in the center roof locker and runs to the rear or wardrobe TV.

Portable Satellite Antenna



Your touring coach is also pre-wired for a portable satellite antenna or external cable hookup. The exterior inlet is located on the side of the touring coach and is labeled for your convenience. The interior pre-wire, consisting of a two-pin power/ground connector and a coax cable pigtail, is located in the front roof locker under where a Blu-Ray player can be placed.

Connected RV Antenna Pre-Wire

The Airstream Touring Coach is pre-wired with a Connected RV high gain, multi-band antenna. This antenna, along with the Airstream router (sold separately), provides access to the internet by creating a local area network.

NOTE

When purchasing an Airstream router to activate the Connected RV features, a data plan will be required. Instructions on setup and data plans will be included with the router.

Appliances

All appliances are delivered to Airstream, Inc., with in-depth owner’s manuals. Those manuals are included in the delivery case supplied by your dealer. The manuals may contain Warnings, Cautions, and operating instruction that should be read and followed before operating the appliances.

The information contained in the appliances manuals supersedes any information contained in the Airstream Interstate Nineteen Owner’s Manual on appliances. If you believe contradictory information on appliances is contained in this manual, or If any appliance manual(s) have not been provided with your vehicle, contact your dealer, the respective appliance manufacturer, or Airstream Customer Service at 937-596-6111 or write:

Airstream Factory Service Center
 428 W. Pike Street
 P.O. Box 629
 Jackson Center, OH 45334-0629
 (937) 596-6111

Maintenance

Follow the instructions and Warnings noted in the respective appliance and equipment owner’s manuals, as well as those mentioned below.

Annual maintenance should be conducted on propane gas appliances and equipment by an authorized dealer or repair facility.

Insects can build nests in the burners of various appliances and equipment. The burner and burner orifice of the propane gas appliances and equipment should be cleaned by an authorized dealer or repair facility any time circumstances or conditions warrant, but no less than on an annual basis.



WARNING

Most LPG appliances used in recreational vehicles are vented to the outside of the vehicle. When parked close to a gasoline pump, it is possible that gasoline fumes could enter this type of appliance and ignite from the burner flame, CAUSING A FIRE OR AN EXPLOSION.

NOTE

Airstream recommends shutting off the gas supply at the LPG tanks before refueling the tow vehicle or entering a refueling station.

Air Conditioner

The roof A/C used on Airstream Touring Coach's are one of the most popular on the market today. In your owner's packet is a set of literature covering all operating and maintenance instructions. If the literature is misplaced, contact the A/C manufacturer or your Airstream dealer for replacement.

Proper voltage to the A/C is critical. A volt meter check may find voltage much lower at a campground shoreline outlet than the needed 110 to 120 volts. Your A/C may not function if the voltage is too low. Low voltage is usually associated with older or poorly maintained motorhome parks. Parking your touring coach so the power cord can be plugged in to a receptacle close to the fuse or circuit breaker box can alleviate low voltage problems. Avoid extension cords and adapters whenever possible. If an extension cord must be used, it should be rated at 30 amps and as short as possible to provide the most current.

If high temperatures are expected, make an effort to park in a shaded area. Starting the A/C early in the morning also helps. It is more efficient to hold a comfortable temperature than it is to lower the temperature after the interior of the touring coach is already hot.

NOTE

Review the air conditioning literature supplied in your owner's packet before proceeding.

Heat Pump

Your air conditioner has a built in heat pump designed to take the chill out of the air. To operate, press the "Mode" button on the thermostat until Heat Pump is selected. The heat pump will run until the temperature reaches the set temperature and then shut off.

NOTE

It is recommended to clean filters Weekly when A/C is in full use.

Cooktop

There is little difference between the operation of home gas ranges and the touring coach's range. If, however, you are used to an electric range, operating confidence can be quickly gained by reading the manufacturer's directions provided in the owner's packet. Manufacturer's service and parts manuals are also available.



WARNING

An operation manual for the range has been provided with your owner's packet. If this has not been provided, contact the listed manufacturer to obtain. Their manual contains specialized warnings and cautions that should be reviewed prior to operating the appliance.

Ceiling Vent Fan



The high-volume roof vent system is designed to quickly exhaust stale, hot air and draw in fresh air. It is great to use when the outside temperature does not call for air conditioning, but heat has built up in your touring coach. The core of the system is a powerful rotary fan that works with a slightly open window to create a balanced airflow. It is designed for maximum air exchange, minimum sound levels and power consumption. Fresh, clean, natural air is pulled in. Hot, stale, stuffy air is pushed out.

The controls for the roof vent have been incorporated into the Multiplex System. The vent lid can be opened or closed by pressing the UP/DOWN arrow buttons on any of the multiplex touch screen control panels located in the front or rear of the touring coach. Select the desired fan speed of either; low, medium, or high.

NOTE

Never place Lindeen™ or a like cover over ceiling fan. Greatly restricted airflow and increased sound levels will occur.

Thermostat and Rain Sensor

The fan is equipped with a built-in thermostat. Set the fan to auto and select your comfort setting on the multiplex control panel and the fan will automatically turn on and off as your touring coach heats up and cools down. When the rain sensor becomes wet the dome will close automatically and shut the fan off. Once the sensor has dried out the dome will reopen and the fan will restart.

NOTE

The vent can be put into auto mode only when HVAC is set to off. In auto the vents will only shut off and close when the temperature is 2° below the set point. Setting the climate control to anything other than off will bring the vent fan out of auto mode.

NOTE

Fan motor will not start if temperature selected is warmer than interior temperature of the coach.

Cleaning Instructions

1. Turn fan motor off.
2. Remove screws around perimeter of screen insert only.
3. Clean screen with soap and water solution, dab dry with a soft cloth, and reinstall.

 **CAUTION**

This product has been manufactured using prime UV stabilized Polymers for maximum toughness and durability. However, the use of non-compatible chemicals will cause cracking and product failure. Please refer to the user’s manual provided in your owner’s packet for more information.

If your vent fails to operate properly under normal conditions, please contact the manufacturer. Please have the touring coach retail sales date and the vent Serial Number readily available when you call. Refer to your operating guide for contact information.

Exhaust Fans



In the bathroom, a round ventilator is used to remove moisture from the air when using the shower. To open, push straight up on the crossbar handle. Once opened, press the red switch to engage the fan motor.

 **CAUTION**

Turn off the fan prior to closing the vent. Damage to the motor can occur if the fan is ran with the vent closed.

Furnace and Water Heater



Heating and warm water in one device:

- 3 selectable modes of power input; LP gas, Electric, and LP/Electric mix.
- During winter operation, the trailer is heated and the water is warmed up at the same time; during summer operation, only the water is warmed up
- The asymmetrical shape of the stainless steel tank enables the water to be mixed more efficiently, so it warms up more evenly and rapidly, which means you can enjoy longer showers without the need to readjust any settings
- The furnace can be operated even if the tank hasn't been filled
- Water, gas and warm air duct connections at the side make servicing easier

Selectable Modes Of Operation

1. Heating Mode - The furnace automatically selects the proper operating level based on the difference between the desired temperature set at the control panel and the current room temperature. If there is any water in the water container, it will be heated automatically. The water temperature will not be regulated, but it will reach a maximum of 162°F.
2. Hot Water Mode - Hot water mode is ideal if only hot water is required. The lowest burner setting suffices for heating water. In hot water mode, the burner will switch off as soon as the water reaches the temperature selected at the CP Plus Control Panel.

NOTE

Make sure the water and bypass valves are in their normal operating positions. If the bypass valve is left open cold water will be mixed with heated water. This will lead to an insufficient hot water supply. The bypass valve is accessed under the roadside ottoman and is located on the right side of the water heater.



WARNING

The furnace/water heater does not feature a frost-protection function. The water container must be drained if the trailer will not be used whenever there is a risk of frost.



WARNING

The water heaters manufacturer does not recommend blowing air through the water heater system when draining. This method could cause damage to lines and components. Refer to the manufacturers user's manual provided for complete winterization instructions.

NOTE

If warranty service is required, use only a service location recommended by the furnace manufacturer or your Airstream dealer.

Truma Combi CP Plus Control Panel



The CP Plus control panel controls and monitors the Truma Combi™ furnace with additional indirect water heater.

1. Display
2. Status line
3. Menu line (top)
4. Menu line (bottom)
5. Power supply display 120 VAC (main supply)
6. Time switch display
7. Settings/values
8. Rotary push button
9. Back button

NOTE

Before operating the system or control panel, carefully read and follow the operating instructions provide with your owner's packet.

Microwave Ovens

Refer to the Certified Performance Checkout sheet, included in your owner's packet, for manufacturer, model, and serial number information.

Monitor Panel



The display is the only system component that is accessed by the user. The display shown above is located behind the C-Zone panel over the TV. All user input to the display is done using the buttons along the bottom of the display.

NOTE

The following information is for use of the SeeLevel II Monitor Panel. The Multiplex Systems main control panel can also be used.

The display receives the information from the three sender pads via a single, two-conductor wire, and displays the level information in percent of full on a three-digit, LED display. When the front panel button for a particular tank is pressed, the display powers up and displays the level for that tank. If the button is pressed and released, the display will show the level for about 5 seconds and then shuts down automatically. If another button is pressed before the display shuts down, then the new level will immediately be shown. If the same button is pressed twice, the display will hold on that tank and continue to show updated levels for 5 minutes before shutting off. This allows the user to monitor the filling or draining of the tank. By pressing two buttons at once, the diagnostic functions can be accessed.

Sender pads are installed and stuck to the sides of the holding tank. The sender pad scans the water level through the tank wall using digital techniques programmed into the sender microprocessor.

To Read a Water or Sewer Tank Level

1. Press the button corresponding to the tank to be checked and release it, the display will show the levels in percent on the LED display. If no other button is pressed, then the display shuts off after about 5 seconds.
2. If another button is pressed before 5 seconds, the display will immediately switch to show the new level or voltage. The 5 second time-out is restarted every time a button is pressed.
3. To continuously display a reading, press and release the desired button, and then press the same button a second time. When the button is released, the display will be on hold mode, which is indicated by the decimal point on the right hand side turning on. While the display is in the hold mode it will recheck the level once per second so the user can watch the level change while the tank is being filled or drained. The display will automatically shut off after 5 minutes in hold mode. To end the hold mode before the 5 minutes is up, press any tank button, and the display will shut off.

To Read the Battery Voltage

1. Press the BATT button and release it, the display will show the battery (House) voltage on the LED display
2. If no other button is pressed, then the display will shut down after about 5 seconds. If the BATT button is held down, the display will continuously recheck the voltage and show the updated value. The reading may flicker back and forth between two values.
3. If another button is pressed before the 5 second time is up for the BATT button, the display will immediately switch to show the value for the new button. The 5 second time-out is restarted every time a button is pressed.

Refrigerator

Review all refrigerator literature supplied in your owner's packet or stored in the refrigerator prior to operating it.

Operation

The refrigerator is all-electric and features a strong 12-volt compressor, which results in a powerful cooling performance. No LPG is required. The ventilation is integrated which also means that outside vents are also not required.

The refrigerator has a very quiet compressor. The standard noise level reaches 32 dB(A). If you want to reduce the noise level further, you can activate the night mode, which drops the noise level an extra three decibel to 29 dB(A).

Even in storage, prevent moisture, mold and unpleasant odors in the refrigerator by holding the door open. Use the sliding latch at the top of the door to keep door open. Remember to keep the freezer door open too.

Defrost and Cleaning

The frequency of defrost is dependant on the number of door openings, the ambient temperature and the humidity level. Typically, it is a good practice to defrost once there is ¼ inch of frost buildup. When defrosting, power off the unit. Prop the door open. We suggest placing a towel in the bottom of the refrigerator and in the freezer compartment to catch excess moisture.

Now that the unit has been defrosted, the interior can be cleaned with a non-abrasive cleaner. Do not use "Brillo" or "SOS" type abrasive pads, as they will score the surfaces. Baking soda is also not recommended.



CAUTION

Speeding up the defrost process with a knife or scraper is strongly discouraged due to the likelihood of rupturing the refrigerant circuit.

Solar System



Airstream utilizes 100 watt solar panels and a Victron charge controller and display. Cut the cord to expensive daily shore power hook-ups with the 12-volt solar charging system. Ensuring the panels are clean and not shaded by trees or other interference, will promote solar charging.

The charge controller gathers energy from the solar panels to charge the house batteries, helping to maintain battery health and extending battery life.

The Airstream Touring Coach is also equipped with a dedicated 50 watt solar panel and charge controller to help keep the chassis battery charged. The solar panel and charge controller will not charge the chassis battery if it has fallen below 11.5 volts, or if the chassis battery has been damaged.

NOTE

The solar panel and charge controller are designed to maintain the chassis battery and help prevent it from dying; they are not designed to charge a dead battery. If the chassis battery is below 11.5 volts it will need to be charged by other means.

Refer to Section 9 - Maintenance for Solar Panel Pre-Wire diagram and information.

Section 6 **EXTERIOR**

EXTERIOR CARE	6-2	AWNING	6-8
WAXES AND POLISHES	6-2	Awning Use In Wind and Rain	6-8
HOW TO CARE FOR YOUR TOURING COACH FINISH.	6-2	Awning Manual Override	6-8
Washing Your Touring Coach	6-3	Care and Maintenance	6-8
Body Kit.	6-3	SCREEN DOORS	6-9
ROADSIDE EXTERIOR FEATURES	6-4	Sliding Screen Door	6-9
CURBSIDE EXTERIOR FEATURES	6-5	Powered Rear Screen	6-9
Windows	6-6	HITCH COVER	6-10
Gravity Water Fill	6-6	How To Remove The Hitch Cover.	6-10
City Water Hookup	6-6	Before Removal	6-10
Exterior Shower	6-6	After Removal.	6-10
Exterior Sliding Step	6-7		
Lock Extended Switch	6-7		
Shoreline Power Supply	6-7		
120-Volt Outlet	6-7		

Exterior Care

The exterior of your Airstream Interstate 19 Touring Coach, except for the body kit, has been painted by Sprinter. The care of the paint is detailed in the Sprinter manual. The following additional information is provided by Airstream to help you understand the finish and its care. Following these instructions will provide a long lasting, high-gloss finish for your recreational vehicle. These same procedures can also be applied to your everyday automobile, producing the same long-lasting results.

NOTE

Information on finish care may provide additional information and tips on the use of the Sprinter Van as a touring coach, however, no information about the exterior finish of your touring coach in this manual should be interpreted as advice or directions to disregard or void the warnings, cautions, or other information contained in the Sprinter's manuals.

Waxes and Polishes

Over 90 percent of all automotive finishes are clear coat. The finish on your touring coach is a state-of-the-art Acrylic Urethane Basecoat/ClearCoat. This means you will wash and polish a clear urethane coating designed to protect the basecoat: the pigmented coating that provides color. As its main function is protecting the basecoat, the clearcoat needs to be maintained especially in harsh environments. Clearcoats do not fade themselves, but appear to fade or lose gloss as the surface becomes contaminated by the environment. If this contamination is not removed frequently, the result will be a dull or low-gloss finish. Occasional washing alone will not adequately remove some forms of contamination and polishing will be required.

Polishes and waxes primarily serve the following purposes:

1. To remove minor surface imperfections caused by water spots and acid rain
2. To remove minor scratches by filling them and leveling the surface
3. To beautify the paint finish appearances with more depth and high-gloss
4. To protect the paint finish from the elements

Do not use products that contain harsh abrasives such as rubbing or polishing compounds. These products should be used by experienced technicians with the proper training and equipment. Most polishes and waxes are designed to clean and polish in one application.

A hand-applied polish or wax will offer outstanding performance and protect the touring coach finish. When applying polish or wax, do so in a shaded area making sure the surface is at the specified temperature according to the polish manufacturer's recommendations. Due to the variations of polishes and waxes, incorporate the following suggestions into the polishing technique:

1. Condition the polishing pad by rubbing a slight amount of polish on it.
2. Use only the amount of polish specified in the label directions.
3. Work a small area at a time.
4. Rinse off and remove dried polish from crevices, trim, and moldings.
5. Follow the products manufacturer's directions.

How to Care for Your Touring Coach Finish

Keeping your touring coach looking its best at all times involves keeping the paint finish clean and in good condition. This means periodic washing and polishing, as well as getting the paint finish repaired as soon as possible when the paint is damaged or affected in any way. The purpose of the paint finish is twofold:

- Provide an aesthetically pleasing appearance.
- Protect the vehicle from the environment.

Your touring coach is exposed to many environmental conditions that have an adverse effect on the paint finish:

1. Road salts and sodium chloride
2. Road tar/bugs
3. Bird droppings/tree sap
4. Industrial fallout/acid rain/pollution
5. Ultraviolet exposure and moisture

The most common problems resulting from these conditions are corrosion, staining, and chemical spotting. These problems can be minimized through regularly-scheduled washing and polishing.

Washing Your Touring Coach

Make sure the touring coach's surface temperature is not too hot, under 90°F, and not in direct sunlight. A shady area is ideal for washing your vehicle, as direct sunlight causes water and soap to evaporate too fast, resulting in water spotting. Use a mild soap or detergent.

Most auto care stores carry a car wash shampoo. Try to avoid combination wash-n-wax products as these waxes cause buildup and are designed for smaller surfaces. Have two dedicated sponges or wax mitts: one for the paint finish and one for the wheels and under carriage. Brushes or wash mitts that have plastic bristles are acceptable for use on tires and wheel wells, but are not intended for use on the paint finish. Avoid using such items on painted surfaces, as they will damage the touring coach paint and finish.

Wash the wheels and wheel wells first as this prevents splattering on already clean panels. Wash from the top and work your way down, frequently rinsing to minimize grit abrasion. Follow with a final rinse of water. This process will remove most contamination from the touring coach's surface. For stubborn stains such as road tar, use an ammonia-based glass cleaner or a small amount of rubbing alcohol on a damp cloth. This may not dissolve the road tar, but will loosen tar and bug stains and remove them from the surface. Do not use solvent-based cleaners on bird droppings or tree sap as these are water-based stains and will eventually dissolve using an ammonia-based glass cleaner, warm soapy water and a little "elbow grease." Once again, after removing stubborn stains immediately rinse with clean water.

Drying the touring coach is just as important as washing your vehicle as today's tap water and well water contain many chemicals that could water stain your touring coach's finish. We suggest using a damp natural or synthetic chamois, however, there are other drying products such as lint free micro-fiber towels that work just as well.

Follow the simple cautionary measures, and your new finish will give you maximum gloss and durability.

It is recommended that the caulking and sealant used in external seams and joints such as window frames, light bezels, beltline, and rub-rail molding, etc., be checked regularly. If this material has dried out and becomes cracked or checked, or if a portion has fallen out, it should be replaced with fresh material to prevent possible rain leaks. Caulking and sealing material is available from your touring coach dealer and most RV supply stores.

Body Kit



The body kit provided by Airstream is made from state-of-the-art high impact plastic. The same material is used in the automotive industry for moldings, bumper guards, and trim. The kit is made to color specifications and requires no paint or finish. The cleaning procedures are the same as the painted finish on the Sprinter body; however, there are several automotive plastic care products on the market for exterior parts that will provide added protection from UV ray damage, dirt, and stains. Find one you like and use it as often as needed to help prevent fading.



CAUTION

When using a power washer, maintain a proper distance from the touring coach. The proper distance is approximately 2.2 ft. when using a round jet nozzle, and 1 ft. when using a 25 degree flat spray jet nozzle. Never point the jet nozzle at moldings, hoses, electrical components, seals, plug connections, etc. Never use round jet nozzles on tires, the pulsating water can damage the sub-structure of tires.

Roadside Exterior Features

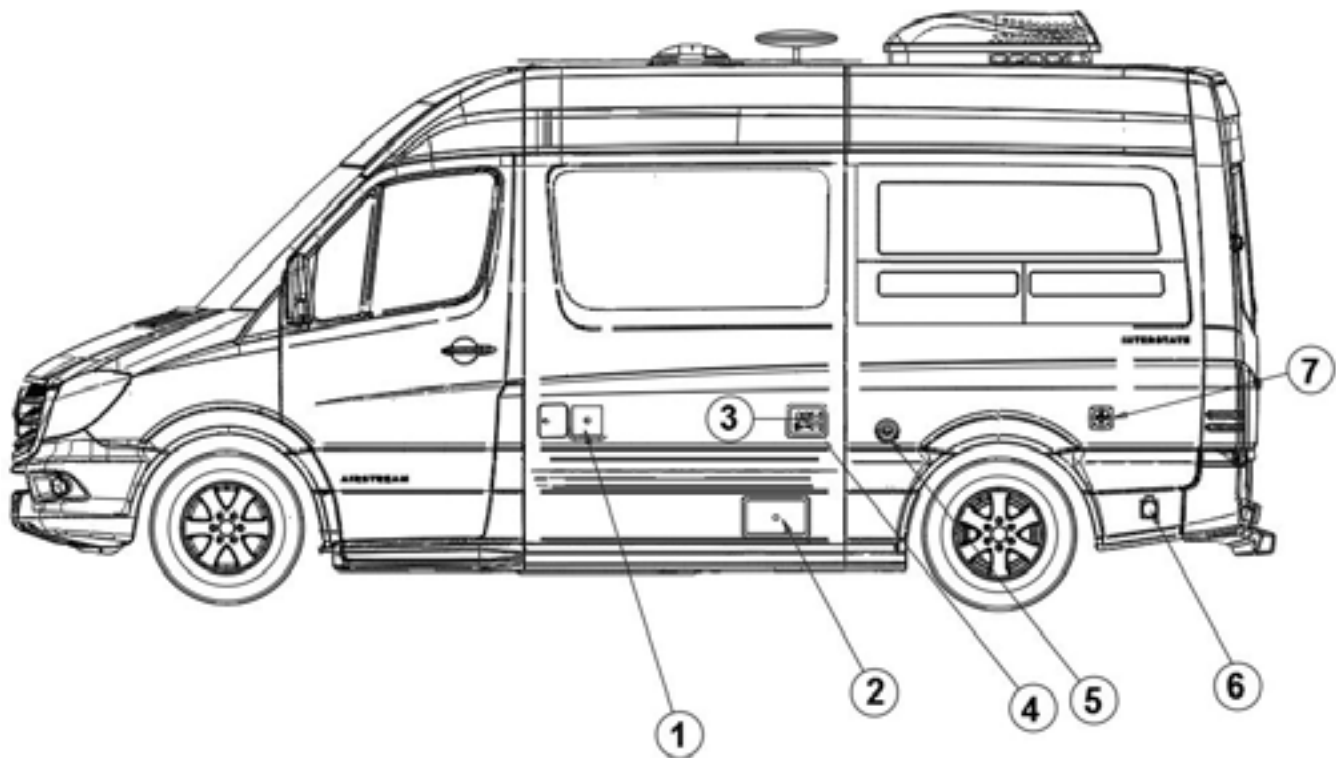

Roadside Exterior Features

NOTE

This is a basic explanation of the location and function of exterior features. More in-depth explanations of certain feature's care and maintenance is include in this manual in other sections.

1. Exterior shower outlet can be used on the water pump or with the city water hookup after faucet/valve/hose assembly is inserted.
2. Macerator hose reel compartment stores the electric reel holding the pump hose and the Black Tank Flush.
3. Utility hatch contains the switches for the dump valves, macerator pump and macerator pump high-pressure hose reel.
4. Cable/Satellite TV inlet is located inside the utility hatch and is pre-wired for cable/satellite TV. A portable satellite dish can be connected and used in the cable connection.
5. Furnace/Water Heater exhaust vent should be cleaned regularly. When operating furnace/water heater, be sure exhaust can escape into a well ventilated area. Air coming from vent can be hot. When parking the touring coach, be sure to have proper clearance in venting area.
6. SmartPlug Power Cord Inlet: the 30 amp power cord is stored inside the vehicle and is used to provide external AC power to the touring coach.
7. City water hookup provides access for city water to your fresh water system. Use ½ inch minimum hose for water supply.

Curbside Exterior Features

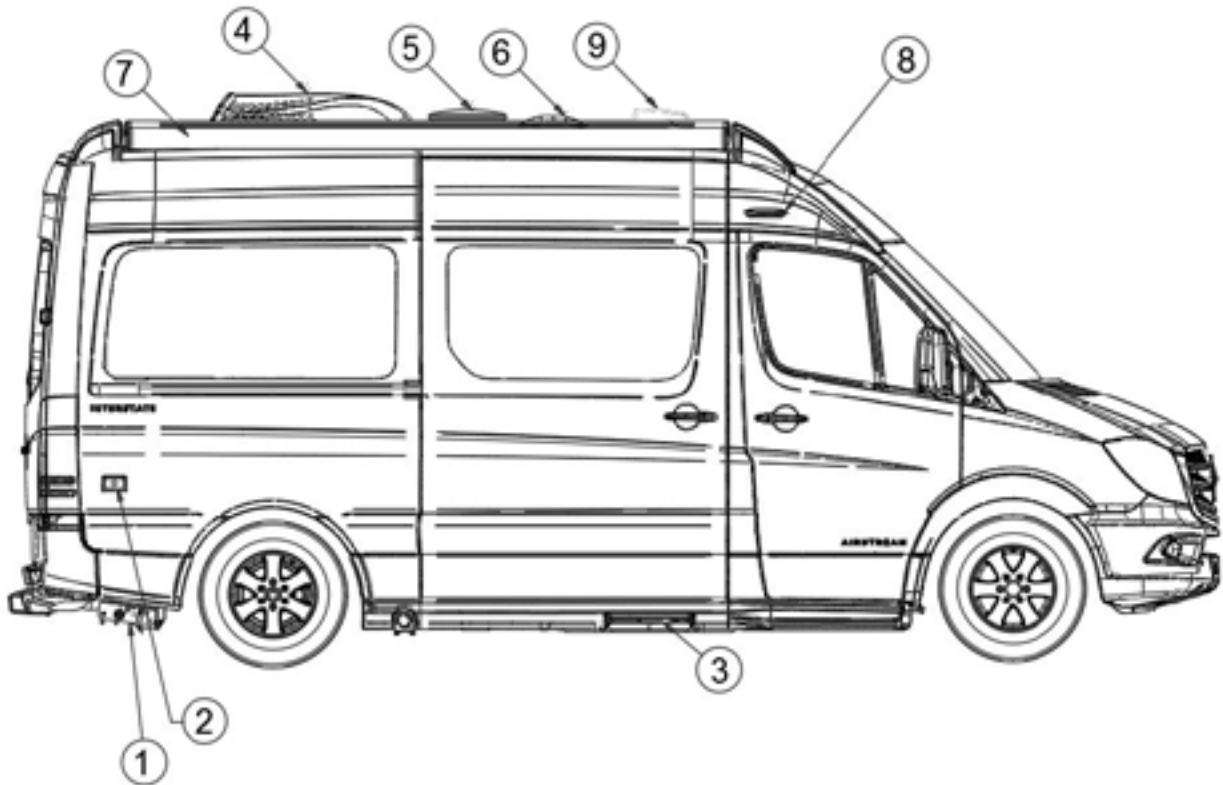

Curbside Exterior Features

NOTE

This is a basic explanation of the location and function of exterior features. More in-depth explanations of certain feature's care and maintenance is include in this manual in other sections.

1. LP tank remote fill and shutoff location.
2. Exterior 120-volt outlet provides an exterior GFCI protected electrical source when plugged into shore power or when the generator is running.
3. Sliding step with auto retract has a step out warning buzzer and a lock extended switch for easy entry into the touring coach.
4. Roof air conditioner
5. Power boosted omni-directional TV antenna is wired into TV outlets on exterior of coach and inside unit at entertainment center cabinet
6. High volume roof vent is an exhaust-only vent. Complete operating instructions are in the appliance section of this manual. Keep all vents clear to encourage airflow.
7. Power Awning
8. Porch light is operated from the main multiplex screen just inside of the entry door.
9. Pre-wired Connected RV antenna. Airstream router required for use.

Windows

Clean your touring coach windows the same way you clean the windows in your home. Clean the seals with a damp cloth and mild detergent every 3 to 6 months. Do not use strong solvents, as they will damage the seals. A coat of natural silicone lubricant applied after the seal has dried will keep it flexible. Spread the lubricant evenly with a brush or finger, working it into the surface. This is a good practice for all rubber seals in your touring coach.



WARNING

Failure to properly clean and lubricate the window seals could result in the window sticking to the jamb and should only be released by a qualified technician trained in the procedure. Do not force, pry, or apply great pressure to open the window. Failure to heed this warning may cause the window to shatter and/or cause personal injury.

For replacement of a damaged window, contact an Airstream Service Center.

Gravity Water Fill

The gravity water fill is located on the backside of the galley cabinet and is accessed when the sliding door is opened. It is used to fill the fresh water tank with potable water. A small vent is located next to the port to allow air to expel from the tank as it is filled.

Fill the water tank by opening the sliding door. A high-pressure RV/Marine FDA approved drinking water hose of at least 1/2-in. diameter made from material that is tasteless, odorless, and non-toxic can now be inserted. It's a good idea to let the water run through a hose for a short time to flush it out. RVers sometimes fill their tanks with "home" water to avoid strange water that may be distasteful to them on short outings. Remember, the more water you carry in the Fresh Water tank, the less cargo carrying capacity you have for other items. The amount of water in the tank may be checked on the Multiplex Control Panel.

NOTE

Since the fresh water tank fill is essentially in the interior of the unit. Please monitor the amount of water you are putting into the tank to ensure that you do not have overflow into the coach.

City Water Hookup



The city water hookup is located on the roadside of the touring coach. For consistent water flow and plumbing line safety, an in-line regulator limits pressure to 50 psi.

Use a tasteless, odorless, non-toxic, high-pressure hose of at least 1/2-in. diameter designed for touring coach use. The city water inlet is a standard garden hose thread. We suggest you carry two lengths of hose in order to reach hookups farther away than normal, as well as to have a spare.

After hooking up the hose and turning on the city water valve provided in the park, slowly open a faucet. There will be a lot of spurts and sputtering until all the air is expelled from the touring coach system. It may take some time before all the air is expelled and a steady flow of water occurs. Once a steady flow is achieved at one faucet, the others should be opened long enough to expel the air in the lines going to them.

Exterior Shower



All units are equipped with an exterior shower. This shower consists of a shower hose, shower head, and water valves inside a lockable exterior door. Water is supplied by the pump or city water hookup. To use: insert the hose into the inlet, pull back slightly to verify it is securely connected. Press the spout button and rotate the faucet handles to the desired temperature. To remove the hose assembly, hold back the water inlet fitting while simultaneously pulling out on the hose fitting. Be sure to press the spout button to relieve any residual pressure before removing the hose.

Exterior Sliding Step

The curbside sliding door has a sliding step with auto retract, step out warning buzzer, and a lock extended switch located just inside the sliding door. Please read, understand, and instruct passengers of the following operational and safety information pertaining to the step.

The step extends and retracts as the sliding door is opened and closed with the engine off and step lock extend switch off. The step retracts automatically and will not extend when the engine is started to prevent damage while in transit.

If the step does not retract fully, a warning buzzer will sound. The vehicle should not be driven if the step fails to retract completely. This buzzer is controlled by a 10-amp fuse.

An undercarriage light, extending from wheel to wheel, has been added for your convenience. This step light can be turned on/off or dimmed using the multiplex panel, located just inside the sliding door, labeled “under coach”.

Lock Extended Switch



To use the lock extended switch, turn the engine off, open the door to extend the step, and turn the switch on. The step will now remain extended while opening and closing the door. Turn the switch off to return the step to normal operating mode.

If you forget to turn the lock extended switch off before starting the engine, the step will retract when the engine is started; however, it will not extend when the engine is turned off and the door is opened. To reset the step, turn the engine off and the step lock extended switch off with the door closed.



WARNING

LOOK BEFORE YOU LEAP. The step will not extend with the opening of the sliding door when the engine is running. Check that the step is extended before leaving and entering vehicle. Failure to follow this warning could result in person injury.

Shoreline Power Supply



Your Aistream is equipped with a SmartPlug power inlet located on the road side of the touring coach. SmartPlug inlets offer superior performance and ease of use. A few features of the SmartPlug include:

- Eliminates Overheating - Increased pin & clip surface area greatly improves electrical conductivity during high amperage demand.
- Ease of Use - No twist required, the unique plug body shape and push-in design means it only goes in the right way every time - even in the dark!
- Multi-Point Locking System - Side clips lock the plug securely into the inlet which eliminates any stress on the pins from movement of the power cord.
- Weatherproof Seals - Multi-fin silicone gaskets installed in the inlet cover and interior of the plug body eliminates moisture penetration.

Many campgrounds provide less than 30-amp service and your hookup may blow their fuse or circuit breaker. If this happens, reduce the load and replace the fuse or reset the breaker.

120-Volt Outlet



The touring coach is equipped with a 120-volt GFCI outlet, located on the curbside. The touring coach must be plugged into a shoreline power supply, or the generator running for the outlet to operate.

Awning

The awning manufacturer provides a complete Owner/Operator Manual for the awning located in your owner's packet. The multiplex panel just inside the sliding door controls the awnings extend/retract feature as well as the awning lights.



WARNING

Awning must be retracted before driving the Touring Coach. Damage may occur if the awning is not properly retracted. The awning will not extend while vehicles engine is running.



CAUTION

Rear doors must be closed when operating the awning or if the vehicle is left unattended, due to seismic sensor, with the awning extended. Damage may occur if the awning is extended or retracted with the rear doors open.

Awning Use In Wind and Rain

The automatic extra strong awning comes with a Direct Response™ System seismic sensor. The Direct Response™ System is an innovative seismic sensor system that automatically activates the 12V motor and retracts the awning in strong winds, thus avoiding possible damage to the awning.

NOTE

If wind or extended periods of rain are expected, retract the awning and secure as for travel. The effects of wind and rain on any awning are unpredictable. Severe damage to the vehicle and or the awning may result and cannot be covered by warranty.



CAUTION

Never use the awning with damaged fabric. Make sure the awning can be correctly retracted.

Awning Manual Override

If power to the vehicle is not available, the awning can be safely retracted using the manual override located on the idler (right) end of the case. A ratchet and socket extension has been included and is located under the passenger side compartment floor.

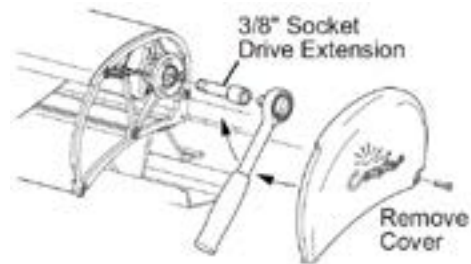

1. Remove thumb screw from backside of decorative awning cap. The cap will be held in place by velcro that must be released before removing.
2. Remove cover from the right end of awning and save.
3. Insert the 3/8" socket drive extension and handle into the square drive hole inside the end cap.
4. Turn the handle clockwise until the awning is retracted.
5. Replace the end cap.



CAUTION

After closing the awning with the manual override, the lead rail may move out from the case 1/4"-1/2". This is normal and the awning is secure for travel until power is restored or repairs are completed. Do NOT attempt to force the lead rail in with the override, serious damage can occur to the awning.

NOTE

Manual override cannot be used to extend the awning.

Care and Maintenance

1. PERIODIC MAINTENANCE Like any other part of the touring coach, an owner should periodically inspect the awning. The following items should be checked.
 - a. All mounting brackets are tight.
 - b. Check all pivot points for enlargements of holes or broken rivets.
 - c. Check end caps for cracking and splitting.
 - d. Check that awning rail is tight against coach and all screws are tight.
 - e. Check canopy for loose stitching and possible shrinkage or puckering.
 - f. Clean and lubricate all tension knobs and pivot points.

Fuse Location: Chassis fuse panel under driver's seat,

Screen Doors

Sliding Screen Door



The touring coach is equipped with an accordion style screen door to provide ventilation and insect control. To operate, carefully pull the screen from its stowed position across the opening. Reverse the procedure when returning the screen door to its stowed position. The screen door should always be in the stowed position when operating the main sliding door, to prevent damage.



The screen above the galley can be opened as well, by sliding the screen up. This screen can be used to pass food, drinks, or other items outside. It can also be used to access the galley's faucet without the need to climb into the touring coach.

 **CAUTION**

Check that the screen door is open before closing the exterior door. Failure to follow this caution could result in damage to the screen door.

Powered Rear Screen



To lower the rear power screen, press the down button on the multiplex control panel once. To stop the power screen in the position that you want, press the button again or allow the screen to stop automatically when it reaches its set limit. To raise the power screen, press the up button on the multiplex control panel.

Hitch Cover

How To Remove The Hitch Cover

Before Removal



After Removal



1. Kneel down behind the rear bumper. There are two black wing nuts on each corner of the cover shown below.



2. Rotate each wing nut 1/4 turn, pull down and remove.



3. Pull straight down to remove cover. Once removed you can store this in one of the rear storage compartments. Reverse these instructions to reinstall. The 7-way Plug is just behind the hitch cover.



Section 7

SPRINTER VAN

IMPORTANT SPRINTER INFORMATION	7-2	CHANGING A TIRE	7-5
Fuel	7-2	Flat Tire	7-6
COMPONENT IDENTIFICATION	7-2	Precautions When Changing a Wheel	7-6
Sprinter Van Serviced by Mercedes-Benz		Procedure	7-6
Sprinter or Its Suppliers	7-2	Jack	7-6
Chassis	7-2	INSTALLING AND REMOVING A WHEEL	7-7
Drivers and Passengers Seats and		Mounting a New Wheel.	7-7
Restraint Systems	7-2	Centering Wheels With Wheel Nuts	7-7
Airstream Components Serviced by		Lowering the Vehicle.	7-7
Airstream Authorized Service Centers or		Wheel Bolt Tightening	7-7
Airstream suppliers.	7-2	TIRE ROTATION	7-8
Cab Area.	7-2	Rotation Pattern For Wheels.	7-8
Living Quarters	7-3	Support	7-8
Electrical Components	7-3	Correct	7-8
Exterior	7-3	Incorrect	7-8
TIRES	7-3		
Vehicle Placard and Tire Inflation Pressure			
Label	7-3		
Proper Tire Inflation	7-4		
Under Inflation	7-4		
How Overloading Affects Your Tires	7-4		
Tires and Wheels	7-4		
Tire Grip	7-5		
Hydroplaning.	7-5		

The Airstream Interstate 19 Touring Coach is integrated into a Sprinter Van designed and manufactured by Mercedes-Benz. Operation of the Sprinter, its engine, power train, and other related components are discussed in the Mercedes-Benz Sprinter Owner's Manual and other literature provided by Sprinter. As a point of reference, those systems discussed in this literature are warranted by Mercedes-Benz or their suppliers.

Important Sprinter Information

Your Mercedes-Benz Sprinter Van Operator's and Warranty Manuals contain important Cautions, Warnings, operational, and warranty information on the Sprinter and its components. All information in the Sprinter manual should be reviewed and followed for your safety. The Airstream Owner's Manual may provide additional information and tips on the use of the Sprinter Van as a touring coach; however, no information in the Airstream manual should be interpreted as advice or directions to disregard or void the warnings, cautions, or other information contained in the Sprinter manuals. If you believe there is a conflict in information, Warnings, Cautions, or safety-related information between the Sprinter and Airstream manuals, please contact the Airstream customer relations department immediately to resolve the conflict.

Fuel

The Mercedes-Benz Sprinter Owner's Manual contains important fuel requirement information on using Ultra-Low Sulfur Diesel, Bio fuels, and very low temperature operation. Please read, understand, and follow this information.

Component Identification

If repairs are needed, it may be difficult to determine which parts are Mercedes-Benz and which are Airstream's responsibility. The following partial lists show the major components of the van and the company responsible for their servicing.

For assistance in locating a service center in the United States:

Customer Assistance Center

Three Mercedes Drive

Montvale, New Jersey 07645-0350

1-877-762-8267

See Mercedes-Benz Sprinter Warranty Information Manual for complete instructions.

Sprinter Van Serviced by Mercedes-Benz Sprinter or Its Suppliers

Chassis

Engine	Speed control
Exterior automotive lights	Automotive electrical system
Engine battery	Instrument panel cluster
Power mirrors	Hitch receiver and tow plug
Engine cooling system	Doors, cab, side and rear cargo
Fog lamps	Heated drivers/passenger seats
Transmission	Cab door windows and windshield
Chassis suspension	AM/FM radio antenna
Brakes	Dash Multimedia Center
Drive axle and hubs	Dash AC/heater/defroster
Steering assembly, Steering wheel	Cargo door assist handle
Rear window defroster and heated windshield	Lane keeper assist
Automotive fuse panel	Blind spot assist
Wheels, Tires	High beam assist
Parking brake	Collision prevention assist
Alternator	Parktronics
Fuel pump	

Drivers and Passengers Seats and Restraint Systems

Sprinter provides the swivel pedestals and Airstream provides the seat decorative skirting and recovers the front seats to match the surrounding decor.

Airstream Components Serviced by Airstream Authorized Service Centers or Airstream suppliers.

Cab Area

Driver's and passenger's seat skirting and covers.

Floor Mats

Dash Kit

Rear View Mirror/Monitor

Vanity Mirrors

Living Quarters

Fire extinguisher	Three piece sun and privacy shield
Interior furniture	Window Coverings
Appliances in the lounge/lavatory area.	Floor covering
Smoke/CO/LP detector	All plumbing systems

Electrical Components

Monitor panel and its system	12-volt living area system
Inverter/Charger	Multiplex System
House batteries	Roof AC
Battery disconnect	TV antenna
Power vents	TVs
120-volt system	

Exterior

Exterior body kit	Air Ride System
Power step	Generator
Exterior lights	Macerator pump
Awning	Solar panels
Windows	

NOTE

Some features listed may not be available on your touring coach.

NOTE

Please contact Airstream or Onan for a service location if repairs are need for the generator.

If you need further clarification or information, contact the Airstream Customer Relations Department at (937) 596-6111 before contacting a service center for an appointment.

If you wish to write, the address is:

Airstream Inc.
 Attn: Customer Service
 428 W. Pike Street
 P.O. Box 629
 Jackson Center, Ohio 45334

Tires

Under inflation or over inflation of tires is dangerous. Under inflation can result in tire flexing, heat build-up, tire overloading, bad handling, bad fuel economy, and uneven wear. Over inflation can result in abnormal wear, bad handling, and a harsh ride.

Tire inflation pressures should be checked as per the Mercedes-Benz Sprinter’s Owner’s manual and when significantly changing the load you plan to carry in your touring coach. Set the correct tire pressure before loading the vehicle. Always check tire inflation pressures when the tires are “cold.” Inflation recommendation is 47 psi for the front tires and 70 psi for the rear. Front and rear pressures are shown for each model and GVWR, and are based on the GVWR and front and rear axle ratings (GAWRs) printed on your vehicle VIN plate and certification label. Tires must be inflated to these pressures when the vehicle is fully loaded or an axle GAWR is reached.

Proper front end alignment improves tire tread mileage. Your front-end suspension parts should be inspected periodically and aligned when needed. Improper alignment may or may not cause the vehicle to vibrate. However, improper toe alignment will cause front tires to roll at an angle, which will result in faster tire wear. Incorrect caster or camber alignment will cause your front tires to wear unevenly and can cause the vehicle to “pull” to the left or right.

Vehicle Placard and Tire Inflation Pressure Label

The TIRE AND LOADING INFORMATION placard supplies information on the size and the cold tire inflation pressure for the original equipment tires supplied with your vehicle. Check the Sprinter manual for all weights and tire information placard location.

A MOTORHOME TIRE SAFETY ADDENDUM is included with your Airstream owner’s packet. Please take the time to read, understand, and follow the information contained in the booklet.

Proper Tire Inflation

The level of air in your tires affects your vehicle's overall performance. Not even the highest quality tire will perform well if it's not inflated properly. The correct pressure varies from vehicle to vehicle and depends in part upon driver preference. Each vehicle has a recommended inflation pressure, usually found on a placard. Check the Sprinter manual for all weights and tire information and the placard location.

Correct tire inflation is a key component in tire care. The recommended inflation pressures for your tires are indicated on the certification label or in your owner's manual. Since touring coach's can be loaded with many different configurations, the load on each tire will vary. For this reason, air pressure should be checked based on the load on each individual tire. Cold Inflation Pressure should be adjusted to handle the maximum tire load, and all tires on the axle should carry the same inflation pressure. Cold tire inflation pressure is the tire pressure checked in the morning before you drive more than a few miles or before rising ambient temperatures or the sun's radiant heat affect it. Check your tire air pressure at least once a month, before each trip, and each morning you drive during a trip. Tire pressure should be checked cold, as tire pressure ratings have been designed with typical running heat/pressure build up in mind. Make sure the valves and caps are free of dirt and moisture.

Under Inflation

Under inflation brings a higher risk of susceptibility to damage due to road hazards, reduces tire casing durability, and causes a loss in fuel economy, plus uneven or irregular tire wear. Severe under inflation brings about an increased risk of tread separation, handling difficulties, and possibly tire failure, which is caused by overheating.

NOTE

It is a common practice for motorhome owners to lower tire pressure in their search for a smoother ride. This is not only dangerous, it is relatively ineffective, and the difference in ride quality is not significant. When minimum inflation pressure requirements are not met, tire durability and optimum operating conditions are compromised. Tire inflation pressure should always meet at least the minimum guidelines for vehicle weight.

- It may be necessary to inflate your tires at a truck stop or truck service center in order to achieve adequate air pressure for your coach's needs
- Only permanent air seal metal valve caps should be used.
- Be safe - if a tire has been run 20 percent under inflated, it must be dismantled and inspected by a trained professional. It should not be inflated without a full inspection or without using a safety cage. Use a calibrated gauge. If your tire is rated for higher inflation pressures, a special gauge designed for larger tires will be required.
- Don't bleed air from warm tires to reduce pressure buildup.
- Don't inflate tires to cold psi rating beyond rim specifications.

How Overloading Affects Your Tires

Tire pressure is what enables your touring coach tire to support loads. Overloading your tires can have serious consequences for passengers and your touring coach. Too much weight can cause stress on your touring coach's suspension system, brake failure, shock absorber damage, handling and steering problems, irregular tire wear and possible tire failure. Excessive loads or under inflation can lead to an excessive amount of heat and tire failure. If you discover that your tires cannot handle the load, lighten the weight of the load on your tires.

Tires and Wheels

(This section is partially excerpted from the Mercedes-Benz Sprinter Van Operator's Manual.)

Check tires regularly for even tread wear, tread depth (note legal requirements), and signs of external damage. Use only wheels and tires of the same size, make, and pattern.

Do not install tires that are not approved for the size and type of wheel installed on the vehicle itself. Only use those wheel sizes that were delivered to you by your authorized Mercedes-Benz Sprinter dealer.

Use only wheels and tires that have been tested and approved by the vehicle manufacturer.

Break in the tires at moderate speeds for a distance of about 65 miles.

**WARNING**

Always replace wheel nuts that are damaged or rusted. Never apply oil or grease to wheel nuts. Damaged wheel hub threads should be repaired immediately. Incorrect mounting bolts or improperly tightened mounting bolts can cause the wheel to come off. This could cause an accident. Make sure to use the correct mounting bolts. Check tightness of wheel nuts regularly and retighten if necessary.

Tire Grip

Tire grip is greatly reduced on a wet or icy road. Speed and driving style must therefore be adapted to suit road conditions. Below a tread depth of 1/8 in., tire grip begins to decrease rapidly on wet roads.

NOTE

California Tire Chain notice: Your motorhome may not be operated with tire chains.

Hydroplaning

Depending on the depth of the water layer on the road, hydroplaning may occur, even at low speeds and with new tires. Reduce vehicle speed, avoid grooves in the road, and apply brakes cautiously in the rain.

The majority of flood-related deaths are caused by people attempting to drive through moving water. Driving into flood waters may be the most dangerous thing one might ever try. Considering the following:

- Most cars will float (and be swept away) in 18-24 inches of moving water. Trucks and SUVs have only 6-12 more inches of clearance. Creeks and rivers can rise very rapidly and the road bottom can also wash away, making the water much deeper than it appears.
- Once cars are swept downstream, they will often roll to one side or perhaps flip over entirely. The driver has a few seconds to escape the vehicle. Many drivers panic as soon as the vehicle submerges and are found later with their seat belt intact.

Changing A Tire

(Partially excerpted from the Mercedes-Benz Sprinter Van Operator's Manual)

After changing a wheel, the wheel nuts must be tightened once the vehicle has been driven for about 30 miles.

If new or repainted wheels are fitted, the wheel nuts must be retighten again after about 600 to 3000 miles. Do not use remolded tires.

**WARNING**

Fitting wheel sizes other than those supplied by Sprinter to the vehicle will change the Sprinter's handling characteristics and may lead to an accident resulting in severe personal injuries, death and property damage.

NOTE

Read the Sprinter manual for wheel torque and wheel tightening procedures.

**WARNING**

The Mercedes-Benz Sprinter Operator's Manual contains important cautions, warnings, specifications, and operational information on changing, maintaining, and replacing of the tires and wheels. Read, understand, and follow the Sprinter manual sections for changing a tire.

**CAUTION**

Changing a tire on a touring coach chassis is a physically demanding procedure. It requires specialized tools and knowledge of safety procedures. Only you can determine your knowledge base and physical ability. Don't take any unnecessary risks. Find a safe area to park your unit, and call a tire service center and supply them with the information in the Sprinter Manual if you have any doubts about changing a tire.

Flat Tire

If you get a flat tire while driving, gradually decrease your speed. Hold the steering wheel firmly and slowly move to a safe place on the side of the road. The pressure of the spare wheel (sold separately) should be checked regularly (at least after every tenth time at the filling station).

The vehicle tool kit is located in a hatch under the front passenger foot well.



WARNING

Use a jack (sold separately) designed exclusively for jacking up the vehicle at the jack take-up brackets built into either side of the vehicle. To help avoid personal injury, use a jack only to lift the vehicle during a wheel change. Never get beneath the vehicle while it is supported by a jack.

Precautions When Changing a Wheel

- Keep hands and feet away from the area under the lifted vehicle.
- Always firmly set parking brake and block wheels before raising vehicle with jack.
- Do not disengage parking brake while vehicle is raised.
- Always use the jack on a level surface.
- Do not jack the vehicle up more than 1-2 in. between the tire and the surface. Otherwise, the vehicle may tip over and may cause serious injury or death to you or others.
- Be sure that the jack arm is fully seated in the jack take-up bracket.
- Always lower the vehicle onto sufficient capacity jack stands before working under the vehicle.
- Do not damage, grease, or oil wheel nuts or stud threads.

Procedure

- Park the vehicle on a firm, level, non-slippery surface.
- Switch on the hazard warning flasher switch, apply the parking brake, and place the transmission selector in “P”.
- Everyone must leave the vehicle before you jack it up.
- Everyone must leave the danger zone before you jack up the vehicle. Danger zones vary with locations. Take a minute and look at what might happen if the vehicle falls off the jack and rolls. Set up your danger zone.
- The vehicle must be safeguarded in accordance with legal regulations (such as using a warning triangle).
- Prevent vehicle from rolling away by blocking wheels with wheel chocks (not supplied with vehicle) or sizable woodblocks or stone. On a level road place one chock in front of and one behind the wheel that is diagonally opposite to the wheel being changed. When changing a wheel on mild uphill or downhill grade, place chocks on the downhill side blocking both wheels of the other axle. Do not jack vehicle up on a steep grade.



WARNING

Do not change wheels on a steep uphill or downhill grade. The vehicle may begin to move and fall from the jack, which could cause property damage, personal injury, and/or death.

Jack

Read, understand, and follow the Mercedes-Benz Sprinter Operator’s manual instructions, cautions, and warnings for changing a wheel and jack point locations.

- Loosen the wheel nuts before raising the vehicle.
- Close the release valve on the jack.
- Assemble the pump lever provided and insert it into the socket on the jack.
- Secure lever by turning it clockwise in the socket.
- Position the jack under the appropriate jack point and raise the vehicle by pumping the lever.

**WARNING**

A jack (sold separately) is intended only for raising the vehicle briefly, for instance when changing a wheel. The jack must be placed on a firm, flat surface only. Do not crawl under the vehicle while it is raised with a jack. Do not start the engine while the vehicle is jacked up. Do not jack the vehicle up more than 1-2 in. between the tire and the surface. The vehicle may tip over and cause serious injury or death to you or others. Jack stands must always be used while working beneath the vehicle. Failure to follow these precautions could result in property damage, personal injury, and/or death.

Installing and Removing A Wheel

- Loosen the wheel nuts.
- Jack up the vehicle until the wheel is clear of the ground.
- Unscrew the wheel nuts and remove the wheel (keep the wheel nuts clean).

NOTE

If the vehicle moves forward or backward while it is being jacked up, lower it, stabilize the vehicle, and repositioned the jack. When the vehicle is jacked up, the jack must stand vertically (plumb-line).

Mounting a New Wheel

- Before fitting the spare wheel, clean rust and dirt off the contact surfaces of the wheel and the wheel hub and from the wheel nuts.
- Note the specified wheel and tire size, tire load capacity, and speed code.
- Do not change the tire's direction of rotation.
- Do not damage, grease, or oil wheel nuts or their threads.

Centering Wheels With Wheel Nuts

- If dual assemblies are used, before placement, the inner wheel should be inspected to ensure all ball bearing rings are in the proper position.
- Install the wheel and snug the wheel nuts.
- Slightly tighten wheel nuts.

Lowering the Vehicle

- Slowly open the jack release valve to lower the vehicle until tire is resting on the ground.
- Tighten the wheel nuts in a crosswise pattern, as specified, with a torque wrench. For tire pressure and wheel bolt torque procedures, see the Mercedes-Benz Sprinter Van Operator's Manual.
- Remove the jack and stow.
- Check the tire pressure. For tire pressures see the Mercedes-Benz Sprinter Operator's Manual.
- Retighten the wheel nuts to the specified torque with a torque wrench after a distance of approximately 30 miles.

**WARNING**

Only certain tires meeting the tire size/load/speed index ratings contained in the Tire Pressure Tables, found in the Index Section of the Mercedes-Benz Sprinter's Operators or Owner's Manual, are certified to conform to FMVSS 120 for the Sprinter Vehicle at this time. Please check the sidewalls of your originally-equipped tires for specific makes/sizes, and speed load ratings when you need to replace your tires. To prevent accident, injury, or possible death, use only the correct tires for your tire replacement.

Wheel Bolt Tightening

Tighten all wheel nuts evenly in the crosswise sequence indicated.

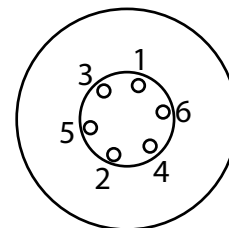
**NOTE**

Consult the Mercedes-Benz Sprinter Operators manual for extensive wheel tightening and wheel torque procedures, cautions, and warnings.

**WARNING**

For safety reasons, the wheel tightening torque must be checked immediately after changing a tire and again after 30 miles to 140 ft-lbs. The wheels could otherwise come loose.

Tire Rotation

Front and rear tires perform different jobs and can wear differently depending on the types of roads driven, driving habits, etc. To obtain the longest tire life, you should inspect and rotate your tires regularly.

Many automotive dealers and tire dealers will perform a free tire inspection to look for uneven or abnormal tire wear.

Tires should be rotated every 6,000 to 8,000 miles. For the longest tire life, any time irregular wear is seen have the tires checked, alignment checked, and tires rotated by your truck or tire dealer. Have the cause of uneven wear corrected.

Rotation Pattern For Wheels

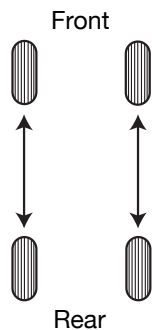

NOTE

Read the Mercedes-Benz Sprinter Operator's Manual for complete instruction on tire rotation, installation, and maintenance.

Support

Since touring coach's may sit for long periods it is important to properly support the tires if blocks are used for leveling.

Extreme caution must be taken to ensure that the tires are fully supported when using blocks to level the touring coach. The load on the tire should be evenly distributed on the block. If not done, the steel cables in the sidewall of the tires may be damaged and could lead to premature fatigue of the sidewall.

Correct

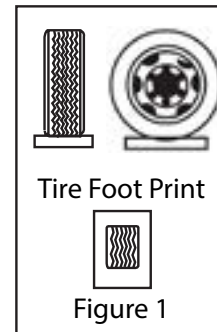

The CORRECT method is shown in Figure 1. The tire is supporting the full load. Please note that the block is wider than the tread and longer than the tire's footprint. This provides maximum support to the tire and ensures that the load is evenly distributed throughout the tire's footprint area.

Incorrect

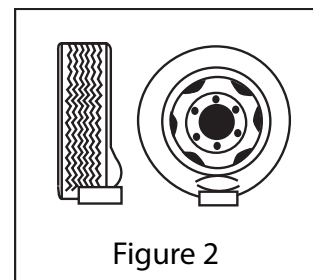

INCORRECT method is shown in Figure 2: A portion of the tire is supporting the full load.



WARNING

Tires that are incorrectly supported may be damaged, which could lead to casing failure resulting in serious injury or property damage. If, on previous occasions, the tires have been incorrectly supported, hidden damage may be present. Please contact your local tire dealer and request an inspection and a determination of possible damage.

Section 8

DRIVING

LOADING	8-2	TOWING A TRAILER	8-6
Weighing	8-2	Tracking	8-6
Vehicle and Trailer Weights and Ratings Definitions	8-2	Brake Controller	8-7
Procedure for Weighing a Touring Coach	8-3	Backing Up	8-8
Weight Distribution	8-3	Camera Monitoring System (360°)	8-8
SAFETY	8-4	Passing	8-8
Seat belts	8-4	Parking Your Touring Coach	8-9
TRAILER TOWING AND DRIVING TIPS	8-4	TOWING YOUR TOURING COACH	8-9
Trailer Hitches	8-4	SAFETY CHECK LIST	8-9
Loading a Trailer	8-5	Exterior Check List (Before Entering Vehicle)	8-9
Checking Weights of Vehicle and Trailer	8-5	Interior Check List (Before Driving)	8-10
Attaching a Trailer	8-5		

Loading

One of the most critical aspects of safely operating a touring coach is knowing the weight involved and where it is placed. The first thing to determine is how much cargo is being loaded and confirming that it is within the capacity of the equipment being used. Determining WHERE that load is placed is critical to the way your rig will handle on the road.

Do not try to guess what your touring coach weighs loaded. Load your touring coach including water, propane, etc and take it to a public scale. Weigh each axle of your vehicle. Refer to your axle weight and tire limits to see if you are within a safe range. Total all axle weights and make sure you are below the GVWR. If you are not overloaded, make sure your load is balanced. Do not load too much on one side. A balanced load is much easier to tow or drive.

Front to back balance is also important. Step back and look at your touring coach. Make sure there is not too much weight in the front or on the rear of the touring coach. Be sure to secure all items. Loose items can cause damage and can be a safety issue.

The Cargo Carrying capacity tag shown below is installed on every touring coach and can be found on the inside of the door on your vehicle.

MOTOR HOME OCCUPANT AND CARGO CARRYING CAPACITY VIN ##### THE COMBINED WEIGHT OF OCCUPANTS AND CARGO SHOULD NEVER EXCEED XXX kg or XXX lbs Safety belt seating capacity:XXX CAUTION A full load of water equals XXX kg or XXX lbs of cargo @ 1 kg/L (8.3 lb/gal) and the tongue weight of a towed trailer counts as cargo
--

To arrive at “THE COMBINED WEIGHT OF OCCUPANTS AND CARGO SHOULD NEVER EXCEED” number, Airstream weighs the vehicle as finished and adds the weight of full tanks of LP and chassis fuel. That number is subtracted from the GVWR of the touring coach and listed on the tag, The total weight of any and all cargo, including but not limited to dealer or customer modifications or additions, fluids (fresh water and holding tanks), food, clothes, tools, tongue weight of a towed trailer or vehicle, and passengers should never exceed the number listed while the touring coach is in transit.

The “SAFETY BELT SEATING CAPACITY” is the number of passengers that seat belts are provided for.

The “A FULL LOAD OF WATER EQUALS” number is arrived at by multiplying the fresh water tank and water heater capacities by 1Kg/L or 8.34 lb/gal.

When loading the vehicle it is important to keep the GVWR, GAWR, Tire Weight Ratings (listed on the vehicle tire Information placard), and the cargo and occupant capacity in mind and not to exceed these specifications. Your safety depends on not overloading the touring coach, axles, and tires. See the specification section for the weight rating list of these items.

Weighing

To determine the actual weight of your vehicle with personal cargo and water, it must be weighed on scales as you plan to travel. The most common scales are those used by states to weigh trucks along the highway. In rural areas, grain elevators, cement outlets and gravel pits are a good source.

NOTE

Weighing instructions for this touring coach are explained on the next page. If you have trouble locating scales, a call to your State Highway Patrol will usually find them cooperative in assisting you.

Vehicle and Trailer Weights and Ratings Definitions

Gross Vehicle Weight Rating (GVWR) is the maximum permissible weight of the touring coach.

Gross Vehicle Weight (GVW) comprises weight of vehicle including tools, installed accessories, passengers, cargo, and trailer tongue weight. It must never exceed the GVWR.

Gross Axle Weight Rating (GAWR) is the maximum permissible axle weight.

Gross Trailer Weight (GTW) is the maximum permissible trailer weight to be towed.

Trailer Tongue Weight Rating (TWR) is the maximum permissible weight of the trailer tongue. This counts as cargo when loading a touring coach.

NOTE

Check the Sprinter manual for all weights and the tire information placard location.

Front Axle GAWR	GVWR	Rear Axle GAWR	GCWR - GVW
SCALE WEIGHT		Optional Tow Weight	
STEP 1 Front Axle GAW	STEP 2 GVW	STEP 3 Rear Axle GAW	STEP 3a Tow Weight minus Weight of Trailer or Vehicle Towed
INDIVIDUAL WHEEL POSITION WEIGHT			
STEP 4 Left Front Wheel Position	STEP 5 Left Side (Total LF + LR)	STEP 6 Left Rear Wheel Position	
Calculated	Calculated	Calculated	
Right Front Wheel Position Step 1 minus Step 4	Right Front (Total RF + RR) Step 2 minus Step 5	Right Rear Wheel Position Step 3 minus Step 6	

GAWR = Gross Axle Weight Rating
 GVWR = Gross Vehicle Weight Rating
 GCWR = Gross Combination Weight Rating

Procedure for Weighing a Touring Coach

Vehicle should be weighed loaded, as you normally travel.

1. Fill in first row from Specification Section of this manual.
2. Weigh vehicle as shown in row 2 (Scale Weight) and fill in blanks.
3. Weigh one side of vehicle as shown in Individual Wheel Position Weight.
4. Calculate other side as shown in last row.

NOTE

Check the Sprinter manual for all weights and tire information placard location.

Weight Distribution

Touring coach's have fresh water and gray water tanks, a water heater, and storage areas. It gives you great flexibility in loading. With flexibility comes responsibility. If you want to load down all the storage compartments, the amount of fluids may have to be reduced. It's a trade off so plan wisely. Distribute your additional cargo as evenly as possible with the heaviest objects located as low as possible.

Do you really want to carry a full fresh water tank to a RV park 1,000 miles away and then hook up to a city water supply? Even if you're going to a remote area, you can usually fill your water tank shortly before entering the area. Just reducing your load by 10 gallons of water lets you carry an additional 83.4 lb of cargo.

Safety

Seat belts

Federally approved seat belts are provided for the use of the driver, passenger, and the rear sofa. Most states require, by law, that all passengers in a motor vehicle use seat belts while in transit. It is strongly recommended that all occupants remain seated with their safety belts firmly attached while the touring coach is in transit. The driver should adjust his or her seat so that he or she is able to reach all controls easily with the belt on, and be able to use all the travel on the foot brake. Seat belts should be placed as low as possible around the hips to prevent sliding out from under them in case of an accident. This places the load of the body on the strong hipbone structure instead of around the soft abdominal area. Remember, there should only be one occupant per seat belt when traveling.

The driver and front passenger seat belt buckle operation is explained in the Mercedes-Benz Sprinter manual.

The rear sofa buckles are secured by inserting the male end into the female buckle until the buckles are secured. To release the buckle press the release button on the female end.

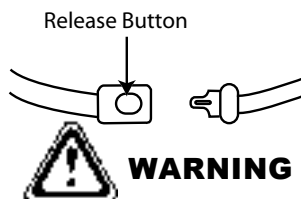

Become familiar with and follow all directions, advice, and warnings pertaining to seats, seat belt operation, and restraint systems, provided in the Mercedes-Benz Sprinter Operator's Manual. Do not allow passengers to ride anywhere in the touring coach except in seats that are equipped with approved seat belts.



Children must be secured in a federally-approved child restraint device. Failure to use proper restraints while in transit can result in severe or fatal injuries. Never place an infant seat that faces to the rear on the front passenger seat. Never place an unbelted infant seat on any seat while in transit.

Child restraint devices are designed to be secured with lap or lap/shoulder belts. All instructions supplied by the restraint manufacturer must be followed. Statistics have shown children are safer when properly restrained in a rear seating position than in a front seating position.

Don't hesitate when it comes to passenger safety. Make sure all passengers are properly restrained.

Trailer Towing and Driving Tips

(Some text is partially excerpted from Mercedes-Benz Sprinter Operators Manual.)



Failure to use proper equipment and driving technique can result in a loss of vehicle control when towing a trailer. Improper towing or failure to follow the instructions contained in this section can result in serious injury. Follow the guidelines below carefully to assure safe trailer operation. Ask your authorized Mercedes-Benz Sprinter or Airstream dealer if you require an explanation of information contained in the manuals.

Trailer Hitches

Units have hitches and wiring installed from the Mercedes-Benz manufacturer. The Sprinter 7- way connector is used for lights and charge line on a trailer. For further information, please see your authorized Mercedes-Benz Sprinter dealer.

To reduce the possibility of damage, remove the hitch ball adapter from the receiver when not in use.

Since this vehicle is designed and intended primarily as a load-carrying vehicle, towing a trailer will affect handling, durability and economy. Maximum safety and satisfaction depends upon proper use of correct equipment and avoiding overloads and other abusive operation.



The total weight of the touring coach and trailer must not exceed the GCWR listed in the specification section of this manual. The maximum towing capacity varies according to the size of the touring coach and its GCWR. Vehicles should be properly equipped for towing trailers. Information on trailer hauling capabilities and special equipment required may be obtained from your Mercedes-Benz Sprinter and/or Airstream dealer.

Loading a Trailer

When loading a trailer, you should ensure neither the permissible GTW (Gross Tongue Weight), nor the trailer GVWR are exceeded.

Maximum permissible values are listed on the safety compliance certification labels for the vehicle and for the trailer to be towed. For their location, see the Mercedes-Benz Sprinter Operator's Manual. The lowest value listed must be selected when determining how the vehicle and trailer are loaded.

To assist in attaining good handling of the vehicle/trailer combination, it is important that the tongue weight be maintained at approximately 10-15 percent of the loaded trailer weight, but not to exceed the hitch rating. Tongue loads can be adjusted by proper distribution of the load in the trailer, and can be checked by weighing separately the loaded trailer and then the tongue.

The tongue weight at the hitch ball must be added to the GVW to prevent exceeding your Sprinter towed vehicle's rear GAWR.

When towing trailers, touring coach tires should be inflated to the highest pressures shown on the Sprinter Tire Information Placard. See Mercedes-Benz Sprinter Operator's Manual for its location. The Cargo Carrying Capacity (CCC) of this vehicle is reduced by the amount that equals the trailer tongue load on the trailer hitch.

Checking Weights of Vehicle and Trailer

To assure that the tow vehicle and trailer comply with the maximum permissible weight limits and to know the actual weights, have the loaded vehicle-trailer combination (tow vehicle including driver, passengers, cargo, and trailer fully loaded) weighed on a commercial scale as explained earlier in this section.

Also, check the vehicles front and rear axle weights and tongue weight. The values as measured must not exceed the Sprinter weight ratings listed on vehicle information placards and in the Mercedes-Benz Sprinter manual. These ratings are also listed in section 4 - Floor Plans, Specification Chart of this manual.

NOTE

Check the Mercedes-Benz Sprinter manual for all weights and tire information placard locations.

Attaching a Trailer

Please observe maximum permitted trailer dimensions (weight and length).

Most states and all Canadian provinces require safety chains between your tow vehicle and trailer. The chains should be crisscrossed under the trailer tongue. They must be attached to the hitch receiver and not to the vehicles bumper or axle. Be sure to leave enough slack in the chains to permit turning corners.

Most states and all Canadian provinces required a separate brake system for towing trailers.



WARNING

The towing vehicle's braking system is rated for operation at GVWR, NOT at the GCWR. A separate, functioning brake system is required for any towed vehicles or trailers weighing more than 1000 lb (450 kg) when fully loaded. NEVER exceed the GVWR, or the GAWR specified on a touring coach certification label. Also, NEVER exceed the weight ratings of a trailer hitch installed on a touring coach. Failure to heed any part of this warning could result in loss of control of the touring coach and towed vehicle or trailer which may cause an accident and serious injury. For specified towed vehicle braking requirements, consult the Mercedes-Benz Sprinter Operator's Manual that comes with this vehicle.



WARNING

Do not connect a trailer brake system (if trailer is so equipped) directly to the vehicle's hydraulic brake system if your vehicle is equipped with anti-lock brakes. If you do, neither the vehicle's brakes nor the trailer's brakes will function properly. Property damage, injury, or death to you or others may be the result.

The provided vehicle electrical wiring harness for trailer towing has a brake signal wire for hookup to a brake controller. Most states and all Canadian provinces require a breakaway switch on trailers with a separate brake system. The switch activates the trailer brakes in the possible event that the trailer might separate from the tow vehicle. Please consider using a trailer sway control system. For further information, see your authorized Mercedes-Benz Sprinter or Airstream dealer.

Towing a Trailer

There are many different laws, including speed limit restrictions, having to do with trailer towing. Make sure that your vehicle-trailer combination will be legal not only for where you reside, but also for where you'll be driving. A good source for this information can be the State Attorney General, State Police, or local authorities.

Before you start driving with a trailer, check the trailer's hitch, breakaway switch, safety chains, electrical connections, lighting, and tires. Also, adjust the mirrors to permit an unobstructed view beyond the rear of the trailer.

If the trailer has brakes using an electric brake controller, start your vehicle and trailer moving slowly, and then apply the brakes manually using the brake controller to be sure the brakes are working properly. Read and follow the controller manufacturer's recommendations.

When towing a trailer, check occasionally to be sure the load is secure, and lighting and trailer brakes (if so equipped) are functioning properly. Always secure items in the trailer to prevent load shifts while driving.

Take into consideration that when towing a trailer, the handling characteristics are different and less stable from those when operating the vehicle without a trailer. It is important to avoid sudden maneuvers.

The vehicle and trailer combination is heavier, and therefore is limited in acceleration ability and requires longer stopping distances. It is more prone to reacting to side wind gusts, and requires more sensitive steering input.

In order to gain skill and an understanding of the vehicle's behavior, you should practice turning, stopping and backing up in an area which is free from traffic.

If possible, do not brake abruptly, but rather engage the brake slightly at first to permit trailer to activate its brake. Then increase the braking force.

We want every owner to be a safe and courteous driver. A few hours of towing practice in a large empty parking lot will make pulling your trailer over the road much easier. Line out two corners for left and right turns. You may also use these corners to practice backing and parking.

Tracking

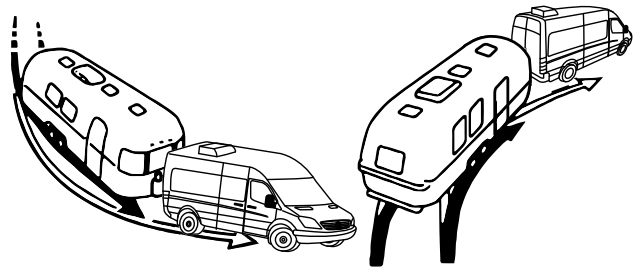

During practice, observe that the tracks made by the trailer wheels are distinctly different from those made by the tow vehicle. Studying this will make it easier for you to correct mistakes. Consider truck- or trailer-type fender or door grip rear view mirrors for maximum visibility. In most states, the law requires them.

After thoroughly inspecting your hitch, brakes, and tires, you should be ready to tow. Check traffic, signal that you are about to pull away, and start slowly. Look often in your mirrors, observe the action of the trailer, and then carefully move into the proper lane of traffic. Remember that the trailer wheels will not follow the path of the tow vehicle wheels; therefore, wider turns are necessary when turning to the left or right.

On freeways or expressways, try to pick the lane you want and stay in it. Always maintain plenty of space between you and the car ahead, at least the length of the tow vehicle plus trailer for every 10 mph. Remember that in order to pass another vehicle, you will need longer to accelerate. You must also allow for the length of the trailer when returning to the right hand lane. On a two-lane road cars may be lining up behind you because you are traveling at a lower speed. It is both courteous and sensible to signal and pull over at the earliest safe opportunity and let them pass.



WARNING

Take into consideration that when towing a trailer, the handling characteristics are different and less stable from those with operating the vehicle without a trailer. It is important to avoid sudden maneuvers. Sudden maneuvers may lead to loss of control over the vehicle-trailer combination.

Brake Controller

The brake controller (if so equipped) is activated when you apply the brakes of the tow vehicle. Your tow vehicle brakes will automatically apply the trailer brakes first when properly adjusted. This will help keep your tow vehicle and trailer in a straight line and make you stop as if you were driving the tow vehicle alone. If swaying or swerving should occur, briefly operating the controller separate from the vehicle brakes may help correct the situation. Practice this maneuver on a clear highway. Do not wait for an emergency and then grope for the controller.

When towing a trailer, you might encounter a temporary cooling system overload during severe conditions such as hot days when pulling on a long uphill grade, when slowing down after higher speed driving, or driving long idle periods in traffic jams. If the hot indicator light comes on, or the temperature gauge indicates overheating and you have your AC turned on, turn it off. Pull over in a safe place and put on your emergency brake. Don't turn off the engine. Increase the engine idle speed. Lift the engine hood and check for fluid leaks at the radiator overflow outlet. Check to see that all drive belts are intact and the fan is turning. If you have a problem have it fixed at the next opportunity. If there is no problem the light should go off or temperature should come down within one minute. Proceed on the highway a little slower. Ten minutes later resume normal driving.

NOTE

If the transmission continually shifts between gears on inclines, manually shift to a lower gear. A lower gear and reduction of speed reduces the chances of engine overloading and/or overheating. When going down a long hill, shift into a lower gear and use the engine's braking effect. Avoid riding the brakes, thus overheating the vehicle and trailer brakes. If the engine coolant rises to an extremely high temperature (e.g. coolant temperature needle approaching the red zone) when the AC is on, turn off the AC. Engine coolant heat can be additionally vented by opening the windows, switching the climate control fan speed to high and setting the temperature control to the maximum hot position.



WARNING

Never open a radiator cap when the tow vehicle is hot. Add coolant when the vehicle is cool.



WARNING

On slippery pavement, do not use engine drag to help slow down as this may cause the rear wheels of the tow vehicle to skid. On icy pavement, drive slowly and if you feel the tow vehicle skidding, gently apply the trailer brakes only. This will bring the tow vehicle and trailer back into a single line. Chains do not help trailer wheels.

When going downhill in dry weather, downshift so that engine compression will slow the whole rig down. Take dips and depressions in the road slowly and do not resume normal driving speeds until you are sure that the trailer wheels are clear of the dip.

When driving in mud and sand, let the momentum carry the rig through. Apply power gently and use as little as possible. Stay in the tracks of the vehicle ahead and keep the tow vehicle in the highest possible gear. If you are stuck, it is best to tow out the entire rig together without unhitching.

Despite even the best hitch, you will notice that whenever a large bus or truck overtakes your rig the displaced air first pushes the trailer rear slightly to the right and then affects the front. It may be necessary to steer very slightly, momentarily, toward the bus or truck to help compensate for the sway induced by the passing-vehicle. Do not apply the vehicle brakes, as this can tend to exaggerate the situation. You may find, however, that briefly applying the trailer brakes with your manual control will help eliminate sway.



WARNING

CHOCK THE TRAILER WHEELS when stopping on a hill or slope. Leaving your tow vehicle in gear is not enough for standstill safety. Do not use trailer brakes as parking brakes.

Backing Up

In BACKING UP the important thing to remember is to DO EVERYTHING SLOWLY and to correct immediately if you see the trailer turning the wrong way. Concentrate on the rear of the trailer. With your tow vehicle and trailer in a straight line, back up slowly and turn the bottom of the steering wheel in the direction you want the trailer to go. Watch from the window or in the mirror until the rear of the trailer is pointing in the desired direction. Your tow vehicle will be following the trailer in an arc. Straighten the tow vehicle and trailer by turning the steering wheel more sharply, and then when they are in line, straighten the steering wheel.

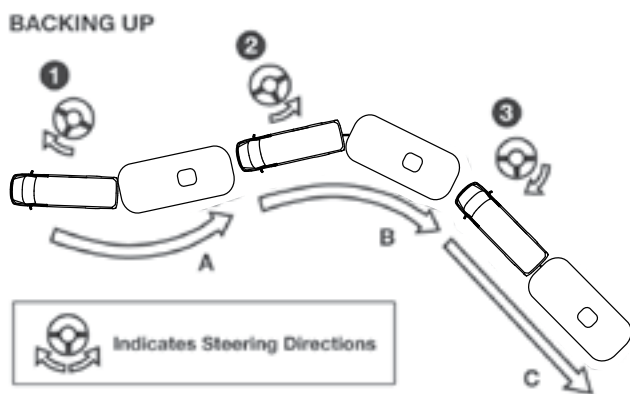

Start in position (A) start. Turning steering wheel as shown in (1). will put you in trailer position (B). Turning steering wheel show in position (2) puts you in trailer position (C). Steering position (3) returns front wheels to straight backing.

NOTE

Always try to back to your left because the visibility is much better.

When you do not make it on the first try it is usually much easier to pull forward to your original straight position and start over.

If your spouse or traveling companion normally directs you when backing they should position themselves forward of the tow vehicle so the driver can easily see them. Their directions should always indicate to the driver the direction the rear of the trailer should go. A little practice in a parking lot with the person giving directions can save a lot of frustration when backing into a campsite.

Camera Monitoring System (360°)

Central to the dashboard is an LCD monitor that displays a 360° live video feed from cameras that are located on all four sides of the Interstate's exterior. These cameras provide video coverage of the vehicle's immediate surroundings. The system is controlled via touchscreen input and has a built-in speaker that provides audible warnings.

The system includes several features that provide supplemental information to the driver. These features are designed to assist you when operating the vehicle in a variety of situations, i.e., while parking or at exits with reduced visibility. Please always remain vigilant. This system is only intended to be used as an aid and is not meant to substitute safe and responsible driving.

NOTE

Prior to operating, please refer to your Mercedes Benz Sprinter manual (provided in your owner's packet) for detailed instructional guides and system limitations.

Passing

Extreme care must be exercised when passing another vehicle. A vehicle with a trailer attached will require additional passing distance than when driving without a trailer. Because your vehicle and trailer is longer than your vehicle alone, you will also need to go much further ahead of the passed vehicle before you can return to your lane.

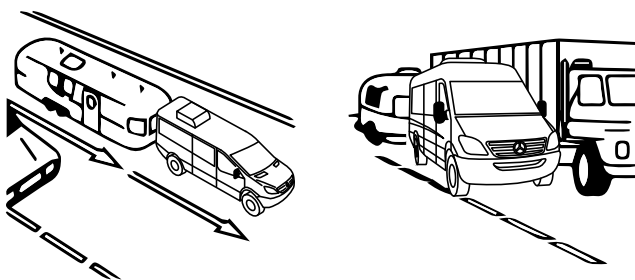

Parking Your Touring Coach

To reduce the risk of personal injury or damage to the vehicle power train as a result of vehicle/trailer movement, always:

- Keep right foot on the brake pedal.
- Shift gear selector lever to position “N”.
- Have a second person place wheel chocks on downhill side of left and right trailer wheels.
- Slowly release the brake pedal allowing the vehicle and trailer to roll into chocks until stopped.
- Press the electronic parking brake button, to the left of the steering wheel.
- Move gear selector lever to position “P”.
- On inclines, turn wheels toward the road curb.

Towing Your Touring Coach

See the Mercedes-Benz Sprinter Operators Manual for towing information.

NOTE

Considerable damage may occur if the touring coach is improperly lifted for towing purposes. Only qualified professional towing service companies with proper equipment should be used. Observe all cautions and warnings in the Mercedes-Benz Sprinter Operator’s Manual before towing your touring coach.

Safety Check List

Your Airstream Touring Coach should be given a thorough safety check before a trip. Regular use of the following list will provide safe operation of your touring coach and will help you spot any malfunctioning equipment and correct the problem as soon as possible. The list is to help you and may not be all-inclusive.



WARNING

Failure to heed the following items may cause damage to the vehicle or personal injury.

Exterior Check List (Before Entering Vehicle)

1. Check condition of tires and keep tires at recommended inflation pressure per the tire and loading placard on the driver’s door B-pillar.
2. Turn off remote LPG valve switch.
3. Check that macerator hose, city water hookup, TV cable/satellite, power cord, and all exterior components are unhooked and properly stowed.
4. Check that all external compartments and filler openings are properly closed, latched, and/or locked.
5. Check that items stored on exterior of vehicle are securely tied down.
6. Verify if any items stored on exterior of vehicle would present a clearance problem.
7. Follow all automotive manufacturer’s recommendations on checking and filling fluid levels.
8. Check exterior lights and general condition of vehicle.

Interior Check List (Before Driving)

1. It is important that all doors be completely closed and locked during travel.
2. Turn off water pump and close all faucets.
3. Check that refrigerator door is closed and latched if equipped.
4. Check that nothing heavy is stored in overhead or high cabinets, which could fall out and cause injury. Heavy items should be stored in lower cabinets.
5. Stow pedestal tables.
6. Check that counter tops, cooktop, and shelves are clear of even small items that could become projectiles during an emergency braking or accident.
7. Do not cook unless the touring coach is parked and stable. Hot food or liquid could scald due to a sudden stop or accident while traveling.
8. Be sure all LPG controls on the appliances are turned off.
9. Check that any internal stowage is securely held in place
10. Check that lights and switches are set in positions safe for travel.
11. Adjust the driver's seat so that you can easily reach and operate all controls. Make sure seat is locked in position. Do not adjust driver's seat swivel or recline mechanisms while vehicle is moving. The seat could move unexpectedly causing loss of control.
12. Check that all passengers have seat belts on properly.
13. The freedom of movement of the brake and accelerator pedals must not be impaired in any way.
14. Check rear view mirrors adjustment, inside and outside. Adjust window coverings if necessary for maximum visibility.
15. Secure children in a federally-approved child restraint device.

Section 9

MAINTENANCE

MAINTENANCE SCHEDULE	9-2	DRAIN AND WASTE SYSTEM	9-11
SUGGESTED MAINTENANCE AND REPLACEMENT PARTS.	9-3	Macerator Pump	9-11
Exterior Care.	9-4	Emptying the Black and Gray Water Holding Tanks.	9-12
TIRE CARE	9-5	Macerator Impeller Release Feature	9-12
Tire Care Tips	9-5	Manual Operation	9-12
Tire Inspection and Storage	9-5	Extended Stays	9-13
LITHIUM IRON PHOSPHATE BATTERIES (HOUSE BATTERIES).	9-6	Black Water Tank Flush	9-13
Lithium Technology	9-6	Drain System Cleaning	9-13
Battery Management System (BMS)	9-6	WINTERIZING AND STORAGE	9-13
Battery State of Charge	9-7	Touring Coach Winterization.	9-14
Cold Weather Usage.	9-7	Water Heater Winterizing	9-15
LPG SYSTEM	9-8	Macerator Pump Winterizing	9-15
LPG Tank Remote Fill	9-8	Restoring Service	9-15
Remote Gas Supply Switch	9-8	Toilet	9-15
LPG Regulator	9-9	Toilet Winterizing	9-15
Exterior LP Port.	9-9	Maintenance	9-16
PLUMBING	9-9	ELECTRICAL DIAGRAMS	9-17
Water System (Self-Contained)	9-9	12-Volt Main Schematic	9-17
Water Pump and Strainer	9-10	30-Amp 120-Volt Schematic	9-24
Sanitizing	9-10	Audio and Video Schematic	9-25
		Standard 30-Amp Circuit Breaker Layout	9-26
		SOLAR PANEL WIRING	9-27
		House Batteries	9-27
		Chassis Battery.	9-27
		MULTIPLEX CONTROLS	9-28
		FRESH WATER LAYOUT	9-31
		FAQS AND ANSWERS	9-32

Maintenance

Maintenance Schedule



WARNING

Failure to maintain your touring coach can cause premature and unexpected parts breakage and/or erratic operation that may be hazardous.

NOTE

See appliance manufacturer's literature for further information.

Every 1,000 miles or 60 days	
Smoke and CO Alarm	Test and replace battery as required.
Tires	Check tire pressure (See Specifications)
GFI Circuit Breaker	Test and record.

Every 5,000 miles or 90 days	
Door Step	Lubricate and inspect moving parts.
LPG Regulator	Check bottom vent for obstructions.
Wheel Lug Nuts	Torque wheels to 140 ft-lbs
7-Way Plug	Spray with contact cleaner.

Every 10,000 miles or 6 months	
Tires	Inspect and rotate.
Windows, and Door Seals	Clean with mild detergent and coat with "Slipicone."
Exterior	Wax

Every year	
Batteries	Check terminals are secured.
LPG Tank	Have purged by LPG supplier.
Seams	Check and reseal exterior seams, windows, lights, and vents as needed.
Interior Cabinets	Visual Inspection of latches Locks, Hinges and Slides. Silicone Spray as needed.

Every 100-150 hours	
Generator	Change oil after the first 20 hours of run time.
	Change oil thereafter every 100-150 hours.
To break in the Onan generator run the generator at 50 percent load for two hours, then at 75 percent load for two hours. Refer to the Onan's manual for more details.	

Suggested Maintenance and Replacement Parts

(Part numbers listed are Airstream part numbers and can be ordered by calling a certified Airstream dealer.)



WARNING

Always replace the bulb or light fixture with the correct bulb for that light or matching fixture. Failure to heed this warning could cause fire, property damage, personal injury, or death.

Exterior 12-Volt Lighting – For additional exterior lights refer to your Chassis Owner’s manual.	
LED Porch Light	PN – 512793
LED Linear Utility Light, 42”	PN – 513672-01
License Plate Light	PN – 511294
LED Pin Light	PN – 512909-01
NOTE: Most Exterior Lighting is LED and a replacement fixture will be required.	

Interior 12-Volt Lighting	
LED Flex Tape Light, 25.75”	PN – 513743-25
LED Flex Tape Light, 35.4”	PN – 513743-36
LED Flex Tape Light, 41”	PN – 513743-41
LED Flex Tape Light, 47.2”	PN – 513743-47
LED Flex Tape Light, 53.1”	PN – 513743-53
LED Shower Light Ring	PN – 513724
LED Domed Surface Mount Light, White	PN – 513745
LED Spot Light w/Frosted Lens	PN – 512987
LED Illustra Tape Light w/Jumpers	PN – 513595
LED Swivel Overhead Light	PN – 513673
LED Aisle Motion Light	PN – 513070
NOTE: Most Interior Lighting is LED and a replacement fixture will be required.	

Replacement Breakers - USA Breakers	
Breaker, Bryant, 30 Amp	PN – 510564-02
Breaker, Bryant, 15-15 Amp	PN – 510564-03
Breaker, Bryant, 20-20 Amp	PN – 510564-04
Breaker, Bryant, 15 GFCI Amp	PN – 510564-07
Breaker, 12V DC Type II, 6 Amp	PN – 510947-06
Breaker, 12V DC Type II, 8 Amp	PN – 510947-08
Breaker, 12V DC Type II, 10 Amp	PN – 510947-10
Breaker, 12V DC Type II, 15 Amp	PN – 510947-15
Breaker, 12V DC Type II, 20 Amp	PN – 510947-20
Breaker, 12V DC Type II, 40 Amp	PN – 510947-40

Replacement Rivets		
	Interior	
Part Number	330127-03	330149
Rivet Name	AD43ABS	ADS46ABSR
Head Style	Dome Head	Dome Head
Body Diameter (Inches)	0.125 (1/8)	0.125 (1/8)
Hole Size	0.129-0.133	0.129-0.133
Drill Number	30	30
Grip Range In (Inches)	0.126-.187	0.125-0.375
Length Under Head (Max. Inches)	0.328	0.960
Head Diameter (Nominal)	0.250	0.312
Head Height (Max. Inches)	0.040	0.060
Typical Sheer Strength (lb)*	155	150
Typical Tensile Strength (lb)*	235	150
*Values shown are a guide only and may vary depending upon the application.		

Replacement Filters	
Air Conditioner	PN – 690323-322

Exterior Care

The following exterior care products are recommended by Airstream. Read and follow label directions. Exterior sealant should be checked and resealed once a year.

Walbernize Super Seal (PN - 28433W) - Use to clean and polish while depositing a reflective, water-proof, glaze finish. Recommend two applications a year.

Acryl-R Seam Sealer (PN - 28430W-01 [16 oz can-Gray]) - Use anywhere a fine bead of gray sealant is required.

Acryl-R Seam Sealer (PN - 28430W-04 [16 oz can-White]) - Use anywhere a fine bead of White sealant is required.

Acryl-R Seam Sealer (PN - 28430W-06 [16 oz can-Clear]) - Use anywhere a fine bead of Clear sealant is required.

AdSeal Premium Quality Sealant Adhesive (PN - 365330-01 [10 oz tube-White]) - Use anywhere a thicker bead of White sealant is required.

AdSeal Premium Quality Sealant Adhesive (PN - 365330-02 [10 oz tube-Gray]) - Use anywhere a thicker bead of Gray sealant is required.

AdSeal Premium Quality Sealant Adhesive (PN - 365330-04 [10 oz tube-Black]) - Use anywhere a thicker bead of Black sealant is required.

Touch-up Caulking	
Caulk, Seamfil, White	PN – 360301-02
Caulk, Seamfil, Tan	PN – 360301-05
Fil-Stik, Black	PN – 28431W-01
Fil-Stik, Gray	PN – 28431W-02
Fil-Stik, White	PN – 28431W-03

Mercedes Sprinter Touch-up Paint Codes	
Iridium Silver	9755
Black	9040
Arctic White	9147

*Paint codes, along with weight ratings, can be found on a sticker attached to the drivers seat pedestal.

Tire Care

The most important function of tires is to provide traction while moving and grip when steering or stopping. The tires on your touring coach are designed for highway use and must be properly maintained in order to maximize tire life, as well to provide a safe mode of transportation.

Tire Care Tips

To reduce the risk of tire failure, we strongly recommend the following:

1. Check the pressure in your tires, including your spare (not provided with vehicle), at least monthly when the tires are cool (after the vehicle has been stopped for 3 hours and then driven less than 1 mi). Do not reduce pressure when tires are hot. Use a tire gauge to check pressure and maintain it at the recommended level.
2. Never overload your tires. Heed the maximum load-carrying capability of your tires.
3. Check your tires frequently for scrapes, bulges, separations, cuts, or snags resulting from use. See your tire dealer immediately if any such condition is discovered.
4. Never operate your vehicle in excess of lawful speeds, the maximum speeds justified by driving conditions, or in excess of speeds recommended for the tires you are using.
5. Make every effort to avoid running over objects that may damage the tire through impact or cutting, such as chuck holes, glass, metal, etc.
6. Never drive on smooth tires. Tires should be removed when 2/32 in. of tread depth remains. In most states, it is illegal to drive with less than 2/32 in. remaining tread depth.
7. Park out of the sun whenever possible when in warm climates. In desert regions, use tire covers to prevent ultra violet light deterioration to tires.

Tire Inspection and Storage

Before taking your touring coach on a trip or when removing it from an extended storage period, make it a practice to inspect the overall condition of your tires. Check for any type of condition or damage that might result in failure. A thorough check should include both inside and outside sidewalls, tread area, and the condition of hardware such as valve stems, valve caps, and wheels. The tread should be checked for any unusual wear, cracking, penetrations, and/or cuts. An uneven wear pattern can indicate misalignment or worn suspension parts.

Since many touring coach's are used seasonally and sometimes stored for extended times, it is possible that tires will take many years to wear out. Tires, as any rubber product, will age over time. If tires show cracking in the sidewall or tread surfaces that are more than 2/32-in. deep, they should be replaced before your next trip or vacation. Store your touring coach in a cool, dry area away from major heat sources and extreme cold. An enclosed storage area is best with no exposure to electromagnetic sources such as generators or transformers. If you must keep your touring coach outside, cover your tires from direct sunlight. Take your touring coach to your tire dealer for service to check or correct any of these conditions.

NOTE

California Tire Chain notice: Your motorhome may not be operated with tire chains.



WARNING

For safety reasons, the wheel tightening torque must be checked immediately after changing a tire and again after 30 miles to 140 ft-lbs. The wheels could otherwise come loose.

Lithium Iron Phosphate Batteries (House Batteries)



Your Airstream Touring Coach is factory-equipped with two 100Ah 12V LiFePO4 deep cycle batteries. The house batteries are located under the coach behind the driver's and passenger's step well.

Lithium Technology

Airstream's lithium batteries require no new hardware, or complicated setup, and are a drop-in upgrade. They are designed to outperform traditional lead acid batteries and offer more usable energy. The Lithium batteries have a life span of approximately 3000-5000 cycles. A cycle is determined by a discharge and a charge. How many cycles a lithium battery can sustain is determined by how depleted a battery is discharged, before it is charged. A battery that is only discharged 50% will have more cycles than a battery that is constantly discharged to 0%.

Lithium batteries provide longer life and faster charging than lead acid batteries, while still providing 80% of the rated capacity, after thousands of cycles. If the batteries are completely depleted, it will take approximately 8 hours to charge the 200Ah battery bank, at 25 amps.

Unlike lead acid batteries, which require water replacement, lithium batteries require no active maintenance. The use of lithium batteries in Airstream's Touring Coach, also provides the benefit of delivering more energy at typically half the weight of a traditional battery.

NOTE

An owner's manual for the lithium batteries is provided in the Airstream Owner's Packet. Make sure to read, understand, and follow all information, such as Notes, Cautions, and Warnings, before operating.

Battery Management System (BMS)

A BMS is crucial in ensuring safe operation of any lithium battery. The BMS monitors cell voltages, currents, and temperatures to make sure they are operating in a safe range. The BMS is sealed internally and will shut the battery down should any fault condition occur. The battery will restart once the fault condition is cleared. The following, are features of the BMS:

- Over/under voltage protection
- High current protection/short circuit
- High temperature protection
- Low temperature charging protection
- Cell balancing



CAUTION

Even though the BMS will protect against issues from overcharging, it should be avoided. The recommended specs are 14.4-14.6 bulk/absorb and below 13.6 float.

The BMS will shut the batteries down when the battery voltage drops below approximately 11.5 VDC. When the batteries shut down, due to Low Battery Cut Off (LBCO), both the main battery disconnect switch and inverter power switch will remain in the positions they were in, prior to the batteries shutting down.

To bring the batteries out of LBCO Mode, a voltage of approximately 11 VDC or greater needs to be applied across the battery terminals. There are two ways of doing this:

1. Start and run the vehicle engine. This will provide alternator voltage of approximately 14.5 VDC across the battery terminals and provide a charge current through the DC-DC converter. The DC-DC converter will limit the charge current to the house batteries to approximately 40 amps. This should take approximately 1 minute.
2. Jump the house batteries with an external battery charger (only one battery will need to be jumped).

NOTE

When the inverter/charger display turns on, the vehicles engine can be turned off, if the coach is plugged in or the generator is started. Otherwise, the engine will need to be ran long enough to fully charge the house batteries.

If the coach is not plugged into shore or generator power, to charge the house batteries, the batteries can go back into LBCO Mode soon after the vehicle's engine is turned off. Bringing the batteries out of LBCO Mode is only "waking up" the batteries and allowing them to take a charge. If wanting to use the generator to charge, the vehicle's engine will need to be ran for several minutes before the house batteries are charged enough to start the generator.

NOTE

If the batteries are in LBCO Mode and it is below 35°F, turn the "Battery Heater" switch to "ON" before performing the wake up procedure.

NOTE

The BMS will not allow a charging current if the internal temperature is below 25°F and it will not allow a charging or discharging current above 135°F.

Battery State of Charge

The heated batteries consume an average of 1.8 amps. Testing indicates, that at 0°F, with no insulation, the heater would be on about 30% of the time. With no other loads or charging, the batteries would give approximately 185 hours of heat capability before the batteries would go into LBCO shutdown.

Voltage	Capacity	Amp Hours Remaining
14.4V	100%	200
13.6V	100%	200
13.4V	99%	198
13.3V	90%	180
13.2V	70%	140
13.1V	40%	80
13.0V	30%	60
12.9V	20%	40
12.8V	17%	34
12.5V	14%	28
12.0V	9%	18
10.0V	0%	0

NOTE

Values are based off a testing environment with the batteries at 100% capacity.

Cold Weather Usage

During the winter, lithium batteries will not take a proper charge if the temperature is below 35°F. To help prevent the batteries from reaching these temperatures, an internal heating element has been installed, which will engage when the temperature drops below 35°F, if the key switch is turned ON. The heating element will automatically engage and disengage, depending on the temperature, and does not require any user involvement.

When storing your touring coach, a key switch located by the rear multiplex display, can be used to turn OFF the battery heaters. This will prevent any parasitic battery draws from the heaters, while the coach is in storage.

NOTE

It is recommended that the battery heater's be turned ON if the outside ambient temperature will drop below 35°F.

LPG System

Your touring coach is equipped with a permanently-mounted tank for LPG with a remote fill and remote gas supply shut off switch. LPG burns with a clean blue flame. LPG is used where subfreezing temperatures are common, since it boils at -44°F . Keep in mind at these temperatures the BTU is lower than at 30°F . How long a full tank of gas will last is dependent on usage. In cold weather, when you are using the furnace, using large amounts of hot water, or cooking extensively, you will naturally use more LPG than you will in warm weather, or when doing limited cooking. On the average, with normal cooking and other appliance use, you can probably count a few weeks of usage from the tank, if you are not running your generator.

If you have allowed the tank to run out, air may have gotten into the lines. In this event the air must be allowed to bleed from the lines before lighting appliances. Follow the appliance manufacturer's instructions and light the appliance closest to the LPG supply tank. Then move to the next closest, etc.

LPG Tank Remote Fill

The LPG tank is filled by accessing the remote fill hookup located in the compartment under the passenger side rear fender behind the rear wheels. Be sure the fill is free of dirt. It may help to remind your LPG supplier to only use a clean fill hose to fill your tank. Turn off the remote switch when the LPG system is not in use, as it draws 12-volt current from the batteries.



WARNING

Only certified LPG suppliers should fill the LPG tank. Turn remote gas supply switch off before filling or refilling LPG tank.



WARNING

Always shut off the LPG gas when refueling the touring coach.

Remote Gas Supply Switch



A remote switch for shutting off the gas to all appliances is located in the rear passenger's side compartment. The switch activates an electric solenoid which opens and closes, shutting the gas off at the tank. This switch should be turned off during the filling of the LPG tank or when LP is not needed to fuel appliances.

Gas lines should be checked periodically for leaks with ammonia-free soapy water.



WARNING

Be careful when working around electricity, as it can carry dangerous amperage and cause sparks or combustion.

NOTE

The electric gas shut-off solenoid closes automatically when 12-volt power is disconnected. It will reopen when power is restored.



WARNING

All LP gas appliances must be turned off during refueling of touring coach fuel tank and permanently-mounted LPG tank.



WARNING

Do not use open flame to search for problems. If gas can be smelled, appliance pilots fail to stay on, or any other abnormal situation occurs, use the remote supply switch to shut off the tank valve immediately and call on a qualified LPG service center or Airstream Service Center.

LPG Regulator

The LPG regulators used on Airstream Touring Coach's are designed for low-pressure service, with a normal outlet pressure setting of 11"-14" water column. Only personnel trained in the proper procedures, codes, standards, etc., should service regulators. Have the regulator inspected each time the tank is refilled. Replace any regulator that has had water in the spring case, or shows evidence of external corrosion or corrosion inside the spring case.



CAUTION

Moisture in the LPG tank will cause a malfunction of the regulator in controlling proper pressure. This may result in the flame lifting off the burner or going out frequently. Many refueling stations will add approximately ¼ to ½ gal of alcohol allowing moisture to pass through the regulator without the formation of ice crystals.

Exterior LP Port

A quick-connect, low-pressure LPG connection is located under the passenger side rear quarter panel behind the dual wheels. It is a utility connection to use for an outside grill or other LPG appliance. Check that the remote LPG shut off switch is turned off. Slide the collar on the female end back and plug the male hose into the connection. Release the collar and check that the hose is properly connected by giving a firm pull on the hose. Turn the LPG remote shut off switch on and recheck all connections to the appliances and quick connection to be sure no leaks are present. Follow all instructions, cautions, and warnings in this manual when connecting and disconnecting appliances.

Plumbing

Water System (Self-Contained)

The fresh water system consists of a city water hookup, fresh water tank gravity fill, fresh water tank and drain valve, water pump, hot and cold water lines, water heater, fresh water line low point drain valves, and faucets. Full explanations on the locations and use of these features are explained in this section.

Before using the water system, check that the water heaters drain valve is closed. See Winterizing and Storage for further information on the drain valve. Close all low point drain valves and the fresh water tank drain valve.

Fill the water tank by opening the main sliding door to access the gravity feed water fill cap. A high-pressure RV/Marine FDA approved drinking water hose of at least ½-in. diameter made from material that is tasteless, odorless, and non-toxic can now be inserted. It's a good idea to let the water run through a hose for a short time to flush it out. RVers sometimes fill their tanks with "home" water to avoid strange water that may be distasteful to them on short outings. Remember, the more water you carry in the Fresh Water tank, the less cargo carrying capacity you have for other items. The amount of water in the tank may be checked on the Multiplex Control Panel. Keep watch of the water level as the water fill is essentially on the interior of the unit.

Open the hot side of the galley faucet and turn on the water pump switch located on the monitor panel. For some time, the open faucet may only sputter. This is because the water heater is being filled and air is being pushed out through the lines. Once the water heater is full, a steady stream of water will flow from the faucet. Now, open a cold faucet. It may sputter for a short time, but will soon expel a steady stream. All other faucets can now be opened until all air is expelled. Once the system is filled with water and the faucets closed, the water pump will shut off. When a faucet is opened, the pump will come back on automatically. If the faucet is just barely open, it is normal for the pump to cycle on and off rapidly.

It is normal for a pump to occasionally cycle when all faucets are off to keep the water pressure at the set point. However, if it cycles frequently (e.g. more than a few times an hour) the plumbing system, pump, and pump strainer should be checked to be sure it is not losing pressure through a slow water leak or back through the pump.

NOTE

To prevent equipment damage, the water heater should only be started after the water system is primed and ready for use.

NOTE

Turn the water pump off when the touring coach is left unattended or in motion.

Water Pump and Strainer

The water pump is controlled by the Multiplex Systems control panels. Once the switch is turned on, the pump will run until the water pressure reaches approximately 50 psi. At this point, an internal pressure switch will shut it off. When a faucet is opened, the water pressure will drop and the pump will start to run again.

As a general rule, the water pump should be turned off while using a city water hookup; however, the water pressure at some campgrounds may be low. The water pump can be turned on to assist the city water hookup pressure. Be sure there is some water in the fresh water tank. The pump will only use the water that is needed out of the tank to bring the pressure up to the usual standard of 50 psi.

The water pump and strainer are located under the passenger side powered ottoman seat controlled by the switch on the end of the roof locker and removing the closeout. The strainer should be visually checked for accumulation of sand or debris that could affect water flow.

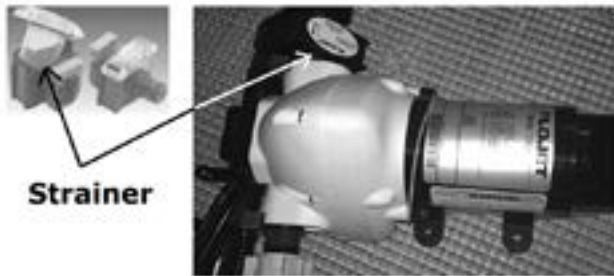

To clean the strainer screen: with the clear plastic at the top, press on the sides of the strainer releasing the tabs holding the clear plastic top in place, hold the sides in, and pull straight up on the clear plastic top to remove the screen assembly. Rinse all debris from the screen. Replace the screen assembly by aligning the screen in the seating grooves and pressing gently down until the tabs catch and hold the clear plastic top in place.

The inlet and outlet hoses and the strainer assembly are held in place by self-sealing, blue, quick-connect fittings. To disconnect a hose or the strainer, grasp the blue tab on the female fitting by the grooved finger edges and pull straight out on the tab. This will release the male fitting connected to the hoses and strainer. Be sure that both the female and male fitting on the disconnect are free of all debris and are not damaged before replacing. Check the pump system for leaks any time the disconnect fittings on the hoses and/or strainer are removed.

CAUTION

Failure to check the quick disconnect fitting for water leaks when reinstalling inlet and outlet hoses or the water pump strainer may cause the pump system to leak, causing damage to personal property.

Sanitizing

Potable water systems require periodic maintenance to deliver a consistent flow of fresh water. Depending on use and the environment the system is subject to, sanitizing is recommended prior to storing and before using the water system after a period of storage. Systems with new components, or ones that have been subjected to contamination should also be disinfected as follows:

1. Use one of the following methods to determine the amount of common household bleach needed to sanitize the tank.
 - a. Multiply “gallons of tank capacity” by 0.13; the result is the ounces of bleach needed to sanitize the tank.
 - b. Multiply “Liters of tank capacity” by 1.0; the result is the milliliters of bleach needed to sanitize the tank.
2. Mix the proper amount of bleach into a container of water.
3. Pour the correct amount of solution (water/bleach) into the Fresh Water tank and fill with potable water.
4. Open all faucets (hot and cold) allowing the water to run until the distinct odor of chlorine is detected.
5. The standard solution must have 4 hours of contact time to disinfect completely. Doubling the solution concentration will allow for contact time of one (1) hour.
6. When the contact time is completed, drain the tank. Refill with potable water and flush the plumbing of all sanitizing solution.

NOTE

The sanitizing procedure outlined above is in conformance with the approved procedures of RVIA ANSI A 119.2 and the U.S. Public Health Service.

Drain and Waste System

Your touring coach has a drain and waste system that includes waste-holding tanks made from corrosion-free, molded plastic, with trouble-free dump valves.

The main (Black Water) holding tank enables you to use the toilet for several days away from disposal facilities. The waste water from the sink, shower, bath, and lavatory drains into the auxiliary (Gray Water) holding tank.

Each tank has its own dump valve with both tanks draining through a common outlet. Therefore, only one sewer hose connection is needed when hooking up to a dump station.

Almost all campgrounds will have dumping facilities. Park directories, such as Woodalls and Rand McNally, also list dumping stations. Furthermore, the navigation systems GPS can be used to locate nearby dumping stations or highlight stations along your route.

Check your monitor panel frequently (main Multiplex control panel or Seelevel monitor). When the Black Water holding tank is completely full, sewage cannot be emptied from the toilet bowl. If the Gray Water holding tank is overfilled, drain water will back up into the shower floor pan and cause an unpleasant cleaning job. Never drain the tanks at any place other than an approved dumping station.



WARNING

Never put wet strength paper towels or tissues in your holding tank since they will not dissolve and can catch in the mechanism of the dump valve. Colored toilet tissue is slower to dissolve than white. Most motorhome accessory stores offer tissue designed for RVs that will completely dissolve.

Macerator Pump

The waste pump is the ideal solution for emptying holding tanks on touring coach's. The macerator section grinds waste down to a particle size of 1/8-in. maximum. The waste pump will macerate and pump all waste and tissue normally found in recreational vehicle waste systems.



CAUTION

The waste hose is pressurized when operating the macerator pump. Secure the loose hose end at the disposal facility with a supplied inlet adaptor before turning on pump.

The high-pressure waste hose is stored on an electric hose reel and connected to the Discharge Port Adaptor. It has a threaded, drip-proof valve with a versatile, two-size, threaded adaptor allowing the valve to be connected to 3 sizes of threaded inlets, including an exterior home sewer clean-out. The adaptor snaps over the valve threads. A rubber ring is also provided to lodge into a non-threaded inlet. If the rubber ring seems loose when used, Airstream recommends using some type of weight to further secure the hose.

Each holding tank, the macerator pump, and macerator pump electric hose reel have individual switches which are located in the roadside utility compartment. Each valve switch has a light that illuminates to let you know the valve is opened. Pressing a dump valve switch and holding it for 2-3 seconds until it is lit opens a holding tank valve. Pressing it again for 2-3 seconds closes it. The macerator pump has an ON/OFF toggle switch. The reel has a switch for releasing and retracting the hose, once the hose is released it is deployed manually by pulling the hose out. To retract the hose, press and hold the retract button while guiding the hose back and forth onto the reel evenly.

NOTE

Do not run Macerator pump more than 15 minutes continuously. Do not run the Macerator pump dry for more than 30 seconds. THE MACERATOR WILL NOT HANDLE HARD SOLID OBJECTS, SANITARY NAPKINS OR RAGS. Never put wet strength paper towels, tissues, or sanitary napkins in your holding tank. They will not dissolve and will jam the mechanism of the dump valve and the macerator pump impeller.

Emptying the Black and Gray Water Holding Tanks

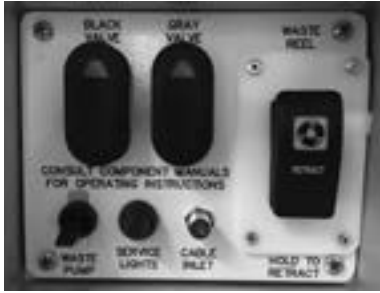

1. Remove the high pressure waste hose by opening the hose reel compartment door and momentarily pressing the “release” switch. Once released, the hose can be manually pulled out. Secure the hose at the disposal facility inlet using the threaded or rubber adaptor and open the drip proof valve on the end of the hose.

CAUTION

The pressure from the macerator pump may push the hose from the inlet if the hose is not secured properly.

2. Open the Black Water valve. Empty the Black Water tank first and the Gray Water tank second, using the Gray Water to help flush the pump and hose of Black Water sewage.
3. Turn on macerator pump to liquefy and pump out the solids in the tank.
4. When black tank is empty, turn off the pump.
5. Open the Gray Water tank valve and turn on the pump. Run until just before the pump runs dry. Any trickle of gray water left will remain in discharge hose behind drip proof valve and is typical. Remember, running the pump dry for more than 30 seconds could damage the pump.
6. Turn the drip-proof valve off and remove the hose adaptor from the dump station inlet. Retract the hose into the hose reel by holding the switch in the “retract” position. Be sure to guide the hose back and forth onto the reel evenly. Close the compartment door.

NOTE

Watch all connections while dumping. Close dump valve immediately, turn off pump, and close hose drip-proof valve if a leak is noticed.

Macerator Impeller Release Feature

Impeller Release Feature



After long periods of non-use, a stuck impeller can be easily broken loose with a screwdriver inserted in the motor shaft slot. Remove the rubber boot, turn the shaft clockwise, and replace the rubber boot. The impeller can usually be found under the touring coach, near the macerator hose reel.

Manual Operation

In case the electric dump valves fail to open, manually pull/push the arm once, to open and close the valve. The manual arm is located under the vehicle, near the macerator hose reel.



Extended Stays

When you are in a park with a disposal facility, empty the tanks every few days or whenever they become almost full. Pumping a large volume of liquid through the tanks at a time will keep toilet paper and other solids completely washed away. Remember to empty the Black Water tank first and then the Gray Water tank using the Gray Water to flush the system. This practice will avoid the accumulation of solids in the tank, which could lead to an unpleasant cleaning job.

Should solids accumulate, fill the tank about half full with water using the black tank flush inlet, and then drive the touring coach for a few miles. Don't wait until the tank is packed solid. The turbulence and surging of the water will usually dissolve the solids into a suspension so the tank can be drained. Draining the tanks as described will protect them from freezing during storage.

Black Water Tank Flush



Inside the macerator hose reel utility compartment is a water hose connector for the “black tank flush.” To use, hook up a garden hose and turn it on. Within the tank, a head with multiple holes will spray the interior surface of the tank. Once the tank is about half full, turn the garden hose off and flush the water from the tank using the macerator pump. The gate valve should be closed for the first couple of minutes, and then opened to let the water out in a rush. Repeat as needed. It is recommended the tank flush be used every time the black tank is emptied or the holes on the spray head may become clogged.

Drain System Cleaning

The only cleaning agents that can be used without causing harm to the system are household ammonia and tri-sodium phosphate in small quantities. Do not use any product that contains any portion of petroleum distillates. This type of product will attack the rubber seals of your toilet and dump valve. Also, do not use any dish detergent or abrasive cleaners. All products should be marked as approved for ABS drainage systems.

Winterizing and Storage

When storing your touring coach, use the same precautions as you would in your own home in regard to perishables, ventilation, winterizing, and rain protection. In addition, for prolonged storage periods, flush out all the drain lines and waste holding tanks. Also, drain the entire water system, including the water heater and the fresh water tank. Instructions for draining the water system are explained in the following paragraphs on winterizing.

Twice a year, or after a long storage period, we suggest you take your unit into your Airstream dealer for a check-up and cleaning of the gas-operated appliances.

The main consideration in winterizing is to guard against freezing damage to the fresh water lines, the waste drain lines, the waste holding tanks, the water heater, and the batteries.

NOTE

Sprinter recommends disconnecting the current to all chassis electric consumers using the engine battery disconnect cable if the vehicle sits for periods longer than 30 days. This will save jump starts, battery charge ups, and possible battery damage and replacement. The Mercedes-Benz Sprinter Operator's Manual describes its location, operation, and cautions in detail.

NOTE

In very cold weather, winterizing the motor coach is recommended to prevent damage to the waste systems.

Touring Coach Winterization

1. Level the touring coach from side to side and front to rear, turn the water pump off, and disconnect the city water.
2. Open all the hot and cold water faucets.
3. Open the low point drain valves for cold water lines, the fresh water tank drain valve, and water heater drain. There are two fresh water line low point drain valves. They are located in the Curbside wheel well. The fresh water tank drain plug is located on the front of the tank under the touring coach. The water heater drain valve is located by the water heater under the roadside ottoman accessed by removing the service panel.
4. Follow the winterizing instructions for your toilet in this manual.
5. While the water is draining from the systems remove, drain, and store the wet bath and the exterior shower hoses and shower heads.
6. After the water has stopped running, apply at most 50 lb of air pressure at the city water inlet. This can be accomplished at a service station if no air compressor is available. Air fittings with regulators can be purchased for the city water inlet. Be sure the toilet flush valve, toilet shut off valve, all drain valves, and all faucets are open and the water pump outlet hose is disconnected. Make sure the water heater bypass valve has been set to its open position and the water inlet and outlet valves have been closed. Air pressure is not recommended to be used on the water heater for winterization.



WARNING

The furnace/water heaters manufacturer does not recommend blowing air through the water heater system when draining. This method could cause damage to lines and components. Refer to the manufacturers user's manual provided for complete winterization instructions.

7. Water pump: The water pump is located under the passenger side powered ottoman seat controlled by the switch on the end of the roof locker and removing the closeout. Remove quick-connect outlet fitting from the pump and turn the pump on briefly to pump out any remaining water from the pump head and lines from the tank. Check the water pump strainer to be sure no water remains. There should be very little water if the tank is drained. Be sure to have a catch pan or a rag under the pump to prevent water from spilling into the touring coach. Leave the fittings disconnected from the pump until the system is ready to be used again. Leave a note on the water pump switch that the plumbing is not connected.
 8. For best practice: remove the house batteries from your touring coach and store them in a cool dry place where there is no danger of freezing. It is very important for optimum life of your batteries to check them periodically and to keep them fully charged. This is especially true in winter months, when the temperature may drop below freezing. If the period of storage is for 30 days or less, you may turn off the battery disconnect switch rather than remove the batteries. Continue to check and recharge the batteries as needed, at least weekly in severe weather.
- An Optional, but not necessary, method for winterizing protection, is to add a non-toxic antifreeze (approved for drinking water system) to the water lines using the following procedure:
1. Reconnect all lines except the one to the pump inlet port and close all drain valves.
 2. Reconnect all lines except the hose to the pump inlet port. Close all drain valves except the water heaters drain valve, it should remain open until the system is ready to be used again. Leave a note on the control panel that the drain valve is open and the bypass valve needs to be closed before use.
 3. Attach a length of hose to the water pump inlet port. This piece of hose should be long enough for the free end to be inserted into and reach the bottom of a RV, non-toxic antifreeze container.
 4. Check that all interior water faucets are still open.
 5. Insert hose length into container containing, RV, non-toxic antifreeze, turn the pump on, and run the water pump until the RV, non-toxic antifreeze solution fills all water lines. Flush toilet.
 6. Open exterior shower faucet until RV, non-toxic antifreeze comes out of the hose, shut off the valve, and remove the drain valve/hose assembly.
 7. Close water fixtures as the RV, non-toxic antifreeze begins to come out. Shut off the pump when RV, non-toxic antifreeze has been distributed throughout the system, and then reopen all faucets to relieve pump pressure.
 8. Disconnect the hose length from the pump inlet fitting, and reconnect water system inlet line.

Water Heater Winterizing

The furnace/water heater has a drain lever located on the water heater, accessed from under the driver's side powered ottoman seat. Move the lever 90° so that it is in the vertical position. Water will drain from the hot water container via the drainage socket. To close, move the lever 90° so that it is in the horizontal position.

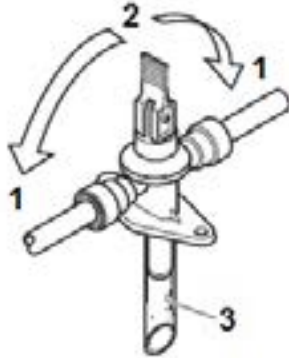

1. Lever in "closed during furnace operation" position.
2. Lever in "drainage" position.
3. Drainage socket.



WARNING

Scalding injury from hot water and/or tampering with the drain valve!



WARNING

When traveling to a location where freezing conditions are likely, or when storing the trailer, be sure to drain all water from the water heater.

Macerator Pump Winterizing

Plan your winterizing and storage ahead, and be sure the holding tanks are drained and flushed thoroughly. This is very important, as the frozen sewage and water could seriously damage the system. After dumping the tanks, add RV, non-toxic antifreeze to one of the holding tanks and start the macerator pump. Run the pump until the RV, non-toxic antifreeze comes out the end of the pump hose, then close the dump valve. As extra protection, open the toilet valve and add RV, non-toxic antifreeze through the toilet into the Black Water tank and pour RV, non-toxic antifreeze into a sink drain to protect the holding tanks, valves, and pump from residual water freezing.

Restoring Service

1. Re-install the fully charged house batteries.
2. Close the low point drain valves, holding tank dump valve, water faucets, and fresh water tank drain.
3. Reconnect water pump line.
4. Add water to the fresh water tank.
5. Turn the water pump on.
6. Open and close faucet valves one at a time until water runs clear at all faucets signaling the RV, non-toxic antifreeze is flushed out of lines. Go back and recheck water clarity at all faucets.
7. Turn off water pump.
8. Hook up city water, open faucet valves, and recheck water clarity.
9. Close water heater drain valve and reset the water heater valve to normal operating position.

Toilet

Toilet Winterizing

Draining Method: Turn off touring coach's water supply. Drain toilet bowl. Disconnect supply line at water valve. Completely drain the toilet's water supply line.

Antifreeze Method: Use RV, non-toxic antifreeze only.

NOTE

To avoid damage when using air pressure to blow water from the lines, make sure the toilet valve is in the open position.

NOTE

If water is frozen in the toilet, do not attempt to flush until the ice thaws. Never use automotive type antifreeze.

Maintenance

Maintenance

If the bowl-sealing blade does not operate freely after extended use, it may be restored to its original, smooth operating condition by applying a light film of silicone spray to the blade. To clean the toilet use Thetford Aqua Bowl or any other high grade, non-abrasive cleaner. Do not use highly concentrated or high acid content household cleaners. They may damage the rubber seals.

Troubleshooting

1. Leaks:
 - a. Back of toilet: check water supply line connection at water valve. Secure or tighten as necessary. If leak persists from water valve, replace.
 - b. Vacuum breaker leaks while flushing: replace vacuum breaker or water module, depending on model.
 - c. Between closet flange and toilet: check flange nuts for tightness. If leak continues, remove toilet and check flange height. Use Thetford spacers to adjust, if necessary, to 7/16-in. above floor. Replace flange seal.
2. Toilet won't hold water:
 - a. Check for and remove any debris from blade-ball seal track.
 - b. Check blade/ball seal compression mechanism. If blade/ball seal is worn, replace.
3. Harder than normal pedal operation: Apply light film of Thetford Toilet Seal Lubricant & Conditioner or silicone spray to blade/ball. (Note: To avoid damage, do not use spray lubricants other than silicone.)
4. Poor flush: The pedal must be held completely down to flush. A good flush should be obtained within 2 to 3 seconds. If problem persists, remove the water supply line and check flow rate.

Electrical Diagrams

12-Volt Main Schematic

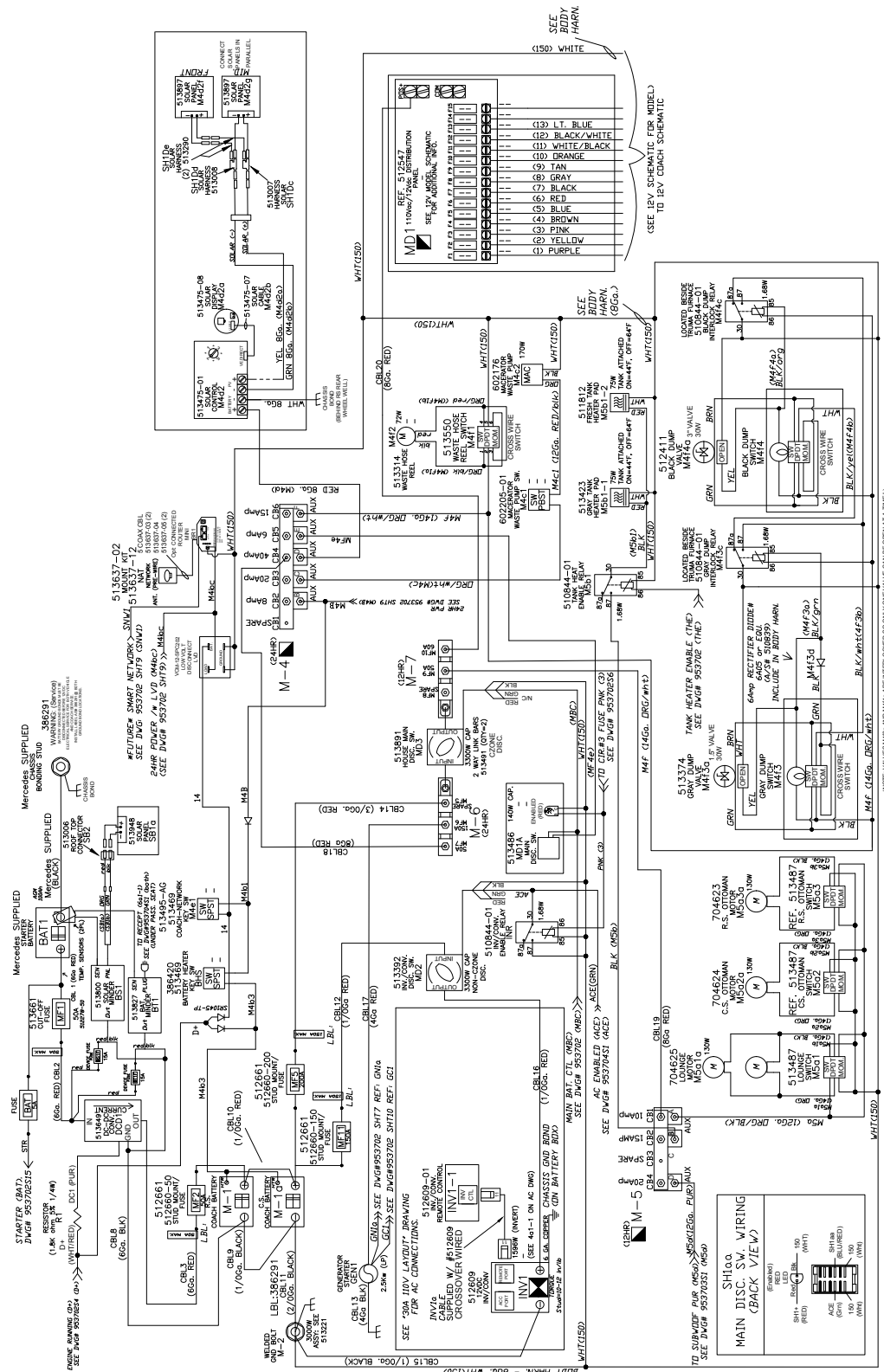

12-Volt Schematic

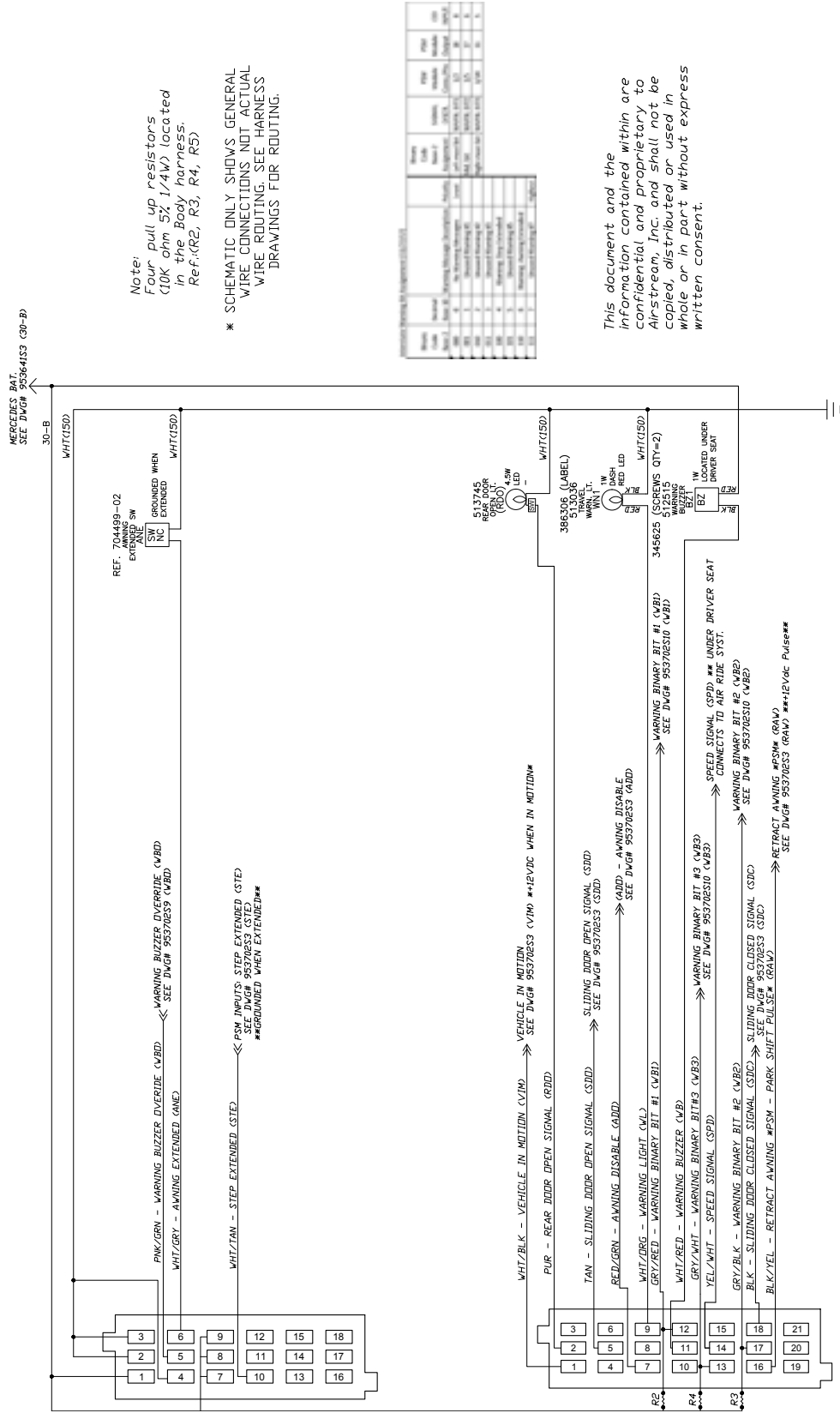

Note:
Four pull up resistors (10K ohm 5% 1/4W) located in the Body harness.
Ref:R2, R3, R4, R5

* SCHEMATIC ONLY SHOWS GENERAL WIRE CONNECTIONS NOT ACTUAL WIRE ROUTING. SEE HARNESS DRAWINGS FOR ROUTING.

Part No.	Part Name	QTY	Unit	Notes
513745	REAR DOOR (RDO) SW (LED)	1	SW	
386506	(LABEL)	1	Label	
513036	WHT/150	1	Wire	
345625	(SCREWS QTY=2)	2	Screw	
512515	WHT/150	1	Wire	

This document and the information contained within are confidential and proprietary to Air-Stream, Inc. and shall not be copied, distributed or used in whole or in part without express written consent.

Maintenance

Standard 30-Amp Circuit Breaker Layout

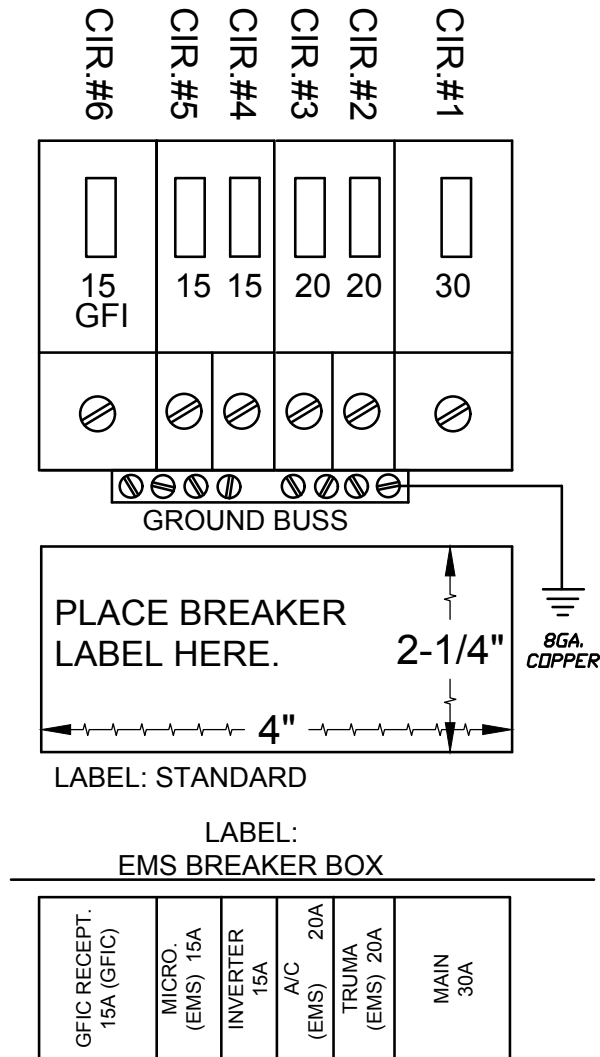

Breaker label content may vary.

Solar Panel Wiring

A manual on the use of the solar system is included with the Airstream Owner's Packet. Please read and understand all information before operating the system.

The charge controller senses the actual battery charge and regulates the charging to prevent over charging. The system requires the 12-volt feed from the battery to operate.

The following diagram depicts the way Airstream wires the solar systems and is the recommended wiring for replacement solar systems.

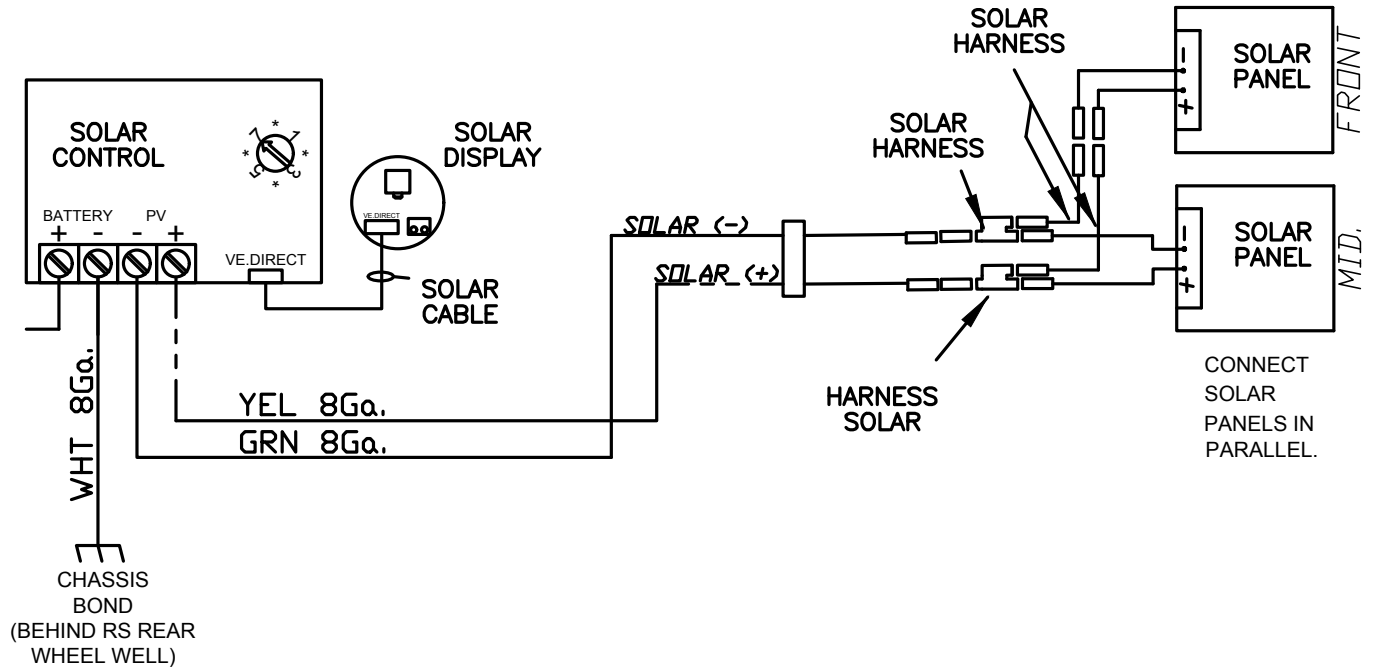





Multiplex Controls

Alarms



Alarms - Notifications

The Alarms Menu will display a list of the alarms that have been triggered by the CZone® system. Alarm notifications are set at the factory and have four severity levels.

-  **Blue - Warning**, this is the lowest alarm severity indicating a minor issue. The alarm will disappear once acknowledged.
-  **Yellow - Standard**, will be provided with a popup dialogue on screen. The alarm will disappear once acknowledged.
-  **Orange - Important**, indicates something is wrong with a system and you will need to investigate before trying to operate it. This alarm will give you an audible tone and popup dialogue on screen. The alarm will remain active in the alarms page.
-  **Red - Critical**, immediate action is necessary to avoid damage and/or a failure of a system. This alarm will give you a popup dialogue and audible tone no matter the screen or action you are currently on. The alarm will return in 10 minutes after acknowledgment until the fault is remedied.

Multiplex Modes

Modes - Three Preset Modes

Away Mode - Can be used when temporarily away from the touring coach while camping. Away mode will power OFF most features to help conserve battery power.

On-Board Mode - Provides an easy one touch ability to turn ON most features of the touring coach

Sleep Mode - Provides an easy one touch ability to turn OFF most features of the touring coach.



Maintenance

Settings

The Settings Menu provides access to information such as: About, Configuration, Display and Sound, Units, System, Battery Calibration, and Reset.

Airstream recommends against changing any settings except Display and Sound, Temperature and Volume, and Date and Time.

Settings such as Dipswitch Settings, and Software Updates should never be changed and could cause the system to quit operating completely. Changing of CZone® system settings via the touch screen control panel may require the touring coach to be taken to a service center for reconfiguration.

NOTE

It is important to know that while system settings can be manually changed most should not. Airstream calibrates the system before leaving the factory and any changes made after may cause the system to function incorrectly or not at all.



Fresh Water Layout

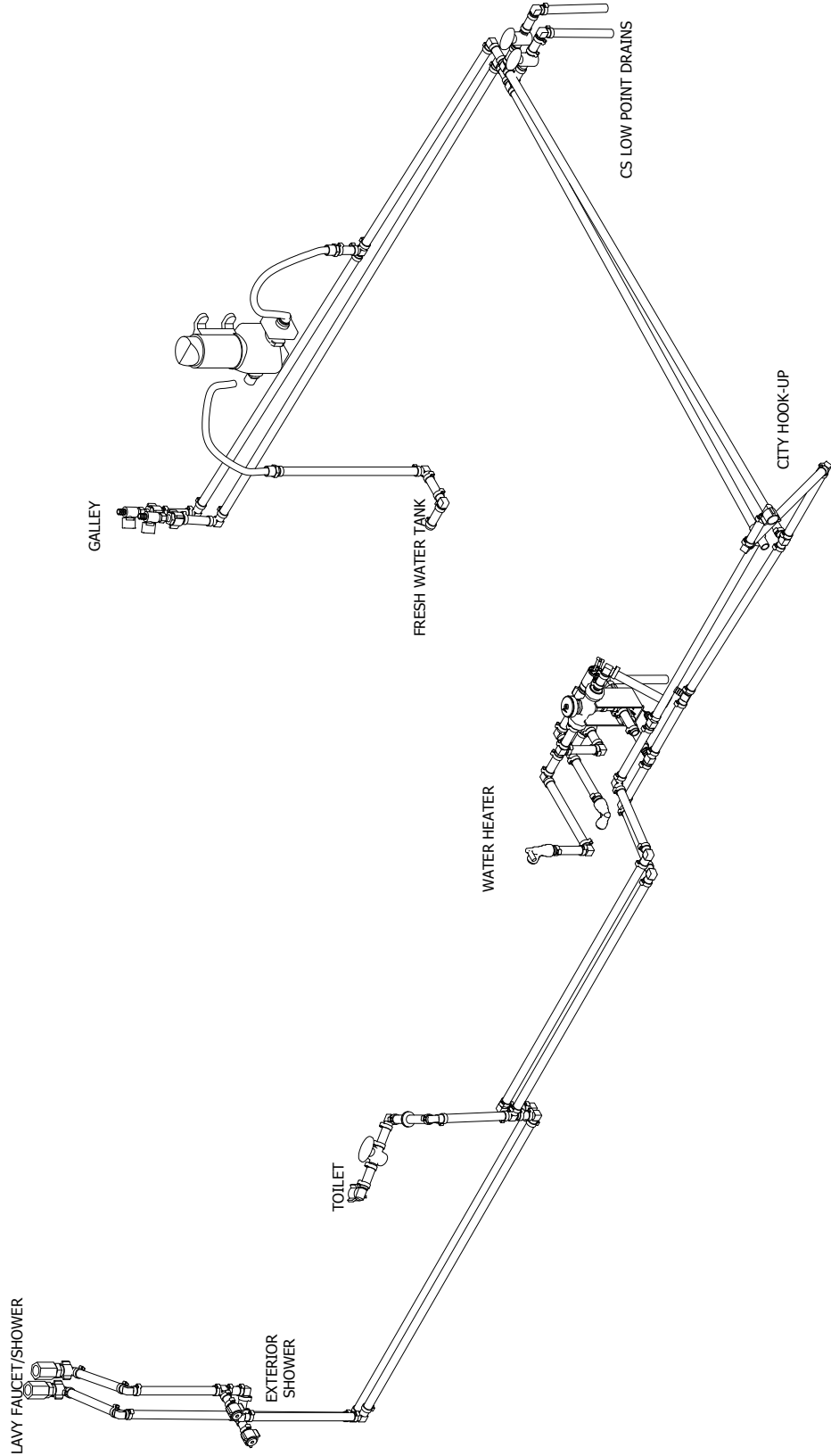

FAQs and Answers

Electrical

- 1. *When I hit my 12-volt remote kill switch, at the sliding door, it does not turn on the 12-volt inside.***

Answer: There could be two issues here. The first is that the batteries are below 8 VDC. If this is the case, there is not enough power to activate the switch. The second issue is that the remote is in the disabled position at the manual knob under the lounge. (Refer to Section 5 - Interior, for more information.)

- 2. *What should I do to maintain my generator?***

Answer: During the initial break in period, you will need to check your oil every 4 hours during the first 20 hours of operation. Once you reach 20 hours of operation, you will need to change the oil. (Refer to the Onans Owner's manual for more information)

- 3. *My generator stalls out or quits running if I turn a corner.***

Answer: Make sure you check the oil level. There is a sensor built into the generator that will shut the engine down if it is too low. Turning the corner or stopping quickly while oil is low can cause this to happen.

- 4. *What size batteries are in my Airstream Interstate 19?***

Answer: Your Airstream is factory equipped with two Battleborn 100Ah 12V LiFePO4 batteries.

- 5. *My generator will not run properly while I am showing I have ¼ tank of LPG; however, it runs fine when tank is showing ½ or more.***

Answer: This could be a demand issue. If you are using other appliances, the outside temperature is below 32°F, and the BTU output is lower than at 72°F, the generator will not run properly. This would cause the generator to stall out or run poorly by not creating the proper 120 volts of power.

- 6. *What is the battery disconnect switch function?***

Answer: The switch is used to cut power when the Interstate Nineteen is not being used or put into storage to preserve battery charge. It disengages or engages the 12-volt power supply from the house batteries to everything but the LPG detector, tank heaters, power lounge, and Magnum inverter.

- 7. *Do you recommend using a surge protector when plugged into shore power?***

Answer: Your Airstream is breaker protected. However, with the use of more personal electronic devices and the number of motorhome users in parks, added protection is always a plus.

- 8. *What is my 1000-watt Magnum inverter powering?***

Answer: It is powering the TV and the Blu-Ray DVD player outlet. There is an additional outlet behind the driver's seat as well. This plug is designed for no more than 1000 watts combined power, and is intended for charging things such as laptops, phones, and TV usage. Plugging in items such as vacuums, hairdryers, etc. may harm the system.

- 9. *I have an alarm going off at my sliding door.***

Answer: Make sure your step and awnings are completely closed. If either of these are not properly closed, and the engine is running, it will cause the alarm to sound.

Plumbing

- 1. *Do I need a water regulator?***

Answer: No, your Airstream is equipped with a built in regulator rated for 50 psi.

- 2. *How do I get fresh water into my Interstate 19?***

Answer: You can use the on board fresh water tank and 12-volt pump for your water supply when camping in a remote area, or hook to an external water source via potable water hose to exterior water inlet when parked at a campground.

- 3. *What is the difference between a Gray Water tank and the Black Water tank?***

Answer: The Gray Water tank holds water from shower and sink drains. The Black Water tank holds sewer water from the toilet.

- 4. *Can I run the macerator pump if there is no water going through it?***

Answer: No, it will burn the macerator up if it is run dry for more the 10-30 seconds. Also, you should not run it more than 15 minutes continuously.

5. How do I use my Black Water tank flush?

Answer: First, empty your Black Water tank, and then close your Black Water tank valve. Hook up your hose to the external hookup, run water through for a couple minutes, and then open the valve. Turn macerator pump on to empty the tank. Do this a couple times until the tank is clear. (Do not run macerator pump if tank is empty.)

6. My Gray Water valve will not open while I have the Black Water valve open.

Answer: True, you can only have one valve open at a time.

Audio-Video**1. My TV reception is poor. What can I check?**

Answer: Verify if your antenna booster is set to proper selection (On- for antenna and Off- for cable satellite). You should also make sure connections are tight on your TV.

2. Will my TV and Blu-Ray player operate while traveling down the highway?

Answer: Yes, if you have your inverter turned on, the rear TV will operate.

3. Does the TV play through the dash stereo?

Answer: No, the TV's audio is not connected to the dash radio.

Chassis**1. Where is my spare tire located?**

Answer: A spare tire is not supplied with the touring coach.

2. How do I jack the touring coach up to change a tire?

Answer: Please refer to the Mercedes owner's manual.

3. Where can I find my touring coach's serial number?

Answer: A label is attached on the driver's side B-pillar or the passenger's door. This label will also provide the inflation pressure of the tires and weight specifications.

Appliances**1. I am planning for a trip in my Airstream. How should I get the refrigerator cooled down?**

Answer: Turn the power on and set the thermostat between 3 and 4. You can make further adjustments to suit your personal requirements after the box has cooled down. Allow the refrigerator to come down to temperature before loading with product. Setting the thermostat to a higher setting, e.g. 7, will not decrease the time required for the unit to cool down to its normal operating temperature. Normal refrigerator operating temperatures are 34°F to 40°F.

2. My air conditioner freezes up. What is the problem?

Answer: In high humidity conditions, the AC manufacturer recommends you operate your AC (manual mode) on the high fan setting and all vents should be open to have maximum air flow over the coils; this helps reduce icing. Also, dirty AC filters can restrict air flow and cause the AC to ice up.

Maintenance**1. Can I have my awning out with heavy winds?**

Answer: No this may cause damage if it is too windy. However, the awning does have a built in sensor that will automatically retract the awning.

2. I want to clean the exterior of my Airstream. What do you suggest?

Answer: Airstream recommends washing the touring coach using a mild, auto detergent, safe for clear coated surfaces. Airstream recommends washing based on operating conditions, and waxing a minimum of twice a year. Any automotive wax designed specifically for clear coated surfaces will provides good wax protection.

Index

A

Air Conditioner 5-18
Alarms and Detectors 2-3
Antennas
 Connect RV Antenna 5-17
 Satellite Antenna 5-17
 TV Antenna 5-16
Appliances 5-17
Awning 6-8

B

Batteries
 Battery Management System 9-6
 Cold Weather Usage 9-7
 Lithium Technology 9-6
Battery Disconnect Switch 5-13
Black Water Tank Flush 9-13
Body Kit 6-3
Brake Controller 8-7

C

Camera Monitoring System (360°) 8-8
Camping 3-7
Carbon Monoxide 2-5
Ceiling Vent Fan 5-18
Chemical Sensitivity 2-2
City Power 5-15
City Water Hookup 6-6
Cleaning
 Exterior 6-2
 Interior 5-3
Converter 5-14
Cooktop 5-18

D

DC-DC Battery Converter 5-13
Drain and Waste System 9-11
Drain System 3-10
Driver and Passenger Seats 5-5

E

Electrical
 12-Volt System 5-7
 120-Volt System 5-15
 Diagrams 9-17
Emergency Exit 2-9
Energy Management System 5-10
 Display Panel 5-11
Exhaust Fans 5-19
Exterior Shower 6-6

F

FAQs and Answers 9-32
Faucets 5-5
Fire Extinguisher 2-9
Floor Plans 4-2
Formaldehyde 2-3
Fresh Water Layout 9-31
Furnace and Water Heater 5-19

G

Generator
 Automatic Generator Start 5-11
 Operation 5-11
 Safety 2-8
Gravity Water Fill 6-6

H

Heated Tanks 3-11
Hitch Cover 6-10

I

Inverter/Charger 5-14

Index

L

- Leveling 3-8
- Loading 8-2
- LPG
 - Detector 2-6
 - LPG System 9-8
 - Regulator 9-9
 - Safety 2-7
 - Tank Remote Fill 9-8

M

- Macerator Pump 9-11
 - Manual Operation 9-12
- Maintenance Schedule 9-2
- Microwave Ovens 5-20
- Molds 3-9
- Monitor Panel 5-21
- Multiplex System 5-8

O

- Overnight Stop 3-7

P

- Plumbing 9-9
- Power Center 5-9
- Power Shades 5-6

R

- Refrigerator 5-22

S

- Safety 2-2, 8-4
- Seat Belts 8-4
- Screen Doors 6-9
- Service 3-6
- Shoreline Power Supply 6-7
- Solar System 5-22
- Specifications 4-3
- Step 6-7

T

- Tires 7-3
 - Care 9-5
 - Changing 7-5
 - Rotation 7-8
 - Size 4-4
- Toilet 5-4
 - Winterizing 9-15
- Towing
 - Backing Up 8-8
 - Towing a Trailer 8-6
 - Towing Your Touring Coach 8-9
 - Weight Distribution 8-3

V

- Ventilation 2-2

W

- Warranty 3-2
- Waste Water System 3-10
- Water Heater (see Furnace and Water Heater)
 - Winterizing 9-15
- Water System 9-9
 - Sanitizing 9-10
 - Water Pump 9-10
- Windows 6-6
- Winterizing and Storage 9-13
- Winter Traveling 3-11

“Wherever you camp, wherever you stay, leave it cleaner than when you arrived. Not just as clean, but cleaner.” – Wally Byam

At Airstream, we take environmental awareness seriously, and we've made it our mission to Leave it Beautiful. That phrase is not just a marketing campaign – it's a reminder that together we can make a difference. Leave it Beautiful is a call to action to pick up the litter, toss it in a can, and not simply step over it and pass it by. Your purchase of a new Airstream will open doors to new experiences and places you've only dreamed of – but it takes all of us working together to ensure those places remain pristine, accessible, and ready for the next adventure.

JOIN AIRSTREAM IN A COMMUNITY EFFORT TO





428 West Pike Street

P.O. Box 629

Jackson Center, OH. 45334-0629

Phone: (937) 596-6111 Fax: (937) 596-7939

www.airstream.com